

## Serie Adapters

 <b>2000</b> Pag. 14.6	 <b>2010</b> Pag. 14.6	<b>New</b>  <b>2020</b> Pag. 14.6	 <b>2030</b> Pag. 14.6	 <b>2040</b> Pag. 14.7	<b>New</b>  <b>2050</b> Pag. 14.7	 <b>2060</b> Pag. 14.7	 <b>2070</b> Pag. 14.8	 <b>2080</b> Pag. 14.8
 <b>2090</b> Pag. 14.8	 <b>2092</b> Pag. 14.9	 <b>2095</b> Pag. 14.9	 <b>2096</b> Pag. 14.9	 <b>2110</b> Pag. 14.9	 <b>2115</b> Pag. 14.10	 <b>2116</b> Pag. 14.10	 <b>3000</b> Pag. 14.10	 <b>3010</b> Pag. 14.10
 <b>3015</b> Pag. 14.11	 <b>3015V</b> Pag. 14.11	 <b>3020</b> Pag. 14.11	 <b>3021</b> Pag. 14.11	 <b>3025</b> Pag. 14.12	 <b>3026</b> Pag. 14.12	 <b>3030</b> Pag. 14.12	 <b>3040</b> Pag. 14.13	 <b>3044</b> Pag. 14.14
 <b>3045</b> Pag. 14.14	<b>New</b>  <b>3047</b> Pag. 14.15	 <b>3050</b> Pag. 14.15	 <b>3055</b> Pag. 14.15	 <b>3060</b> Pag. 14.15	 <b>1704</b> Pag. 14.16	 <b>4000</b> Pag. 14.16	 <b>4010</b> Pag. 14.16	 <b>4020</b> Pag. 14.16
 <b>4030</b> Pag. 14.17	 <b>4040</b> Pag. 14.17	 <b>4050</b> Pag. 14.17	 <b>5000</b> Pag. 14.17	 <b>5010</b> Pag. 14.18	 <b>5020</b> Pag. 14.18	 <b>5050</b> Pag. 14.18	 <b>6000</b> Pag. 14.18	 <b>6010</b> Pag. 14.19
 <b>6020</b> Pag. 14.19	 <b>6025</b> Pag. 14.19	 <b>6030</b> Pag. 14.19	 <b>6040</b> Pag. 14.20	 <b>6047</b> Pag. 14.20	 <b>6048</b> Pag. 14.20	 <b>6070</b> Pag. 14.20	 <b>6080</b> Pag. 14.21	 <b>6090</b> Pag. 14.21
<b>New</b>  <b>82205</b> Pag. 14.21	<b>New</b>  <b>82241</b> Pag. 14.22	 <b>82242</b> Pag. 14.22	 <b>7000</b> Pag. 14.27	<b>New</b>  <b>7005</b> Pag. 14.27	 <b>7010</b> Pag. 14.27	 <b>7020</b> Pag. 14.27	 <b>7030</b> Pag. 14.28	 <b>7040</b> Pag. 14.28
 <b>7050</b> Pag. 14.28	 <b>7060</b> Pag. 14.28	 <b>7070</b> Pag. 14.29	 <b>7080</b> Pag. 14.29	 <b>AS7100</b> Pag. 14.30	 <b>7100</b> Pag. 14.30	 <b>7110</b> Pag. 14.31	 <b>7120</b> Pag. 14.31	 <b>7130</b> Pag. 14.31
 <b>7140</b> Pag. 14.32	 <b>7150</b> Pag. 14.32							

## Serie Food&Drinks - Fittings CW510L

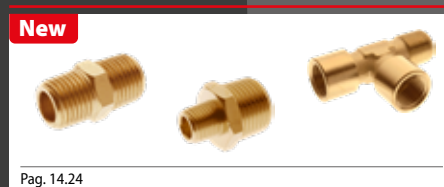

## Serie 1800 - Fittings with bayonet connection



## Serie 15000 - Hose adapters for plastic tubes

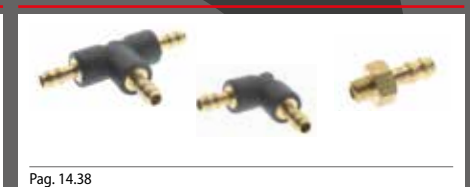

**RACCORDI FILETTATI**

*NICKEL-PLATED BRASS ADAPTORS*

*GEWINDEVERSCHRAUBUNGEN*

*ACCESSOIRES DE RACCORDEMENT- ADAPTATEURS LAITON*

*RACORDAJE ROSCADO*

*ACESSÓRIOS ROSCADOS EM LATÃO NIQUELADO*



**Serie Adapters**

La serie di Aignep, completamente realizzati in ottone nichelato, costituiscono il completamento dell'offerta in termini di adattatori, riduzioni, tappi e componenti per realizzare al meglio le vostre applicazioni e circuiterie. Con prestazioni importanti in termini di pressioni e temperature (+300°C), sono realizzati in una ampia gamma base. Filettature BSPT, BSPP e Metriche.

Completano la gamma un'importante serie di manifold di distribuzione in alluminio e di silenziatori in bronzo sinterizzato e materiali plastici.

### Principali vantaggi

- Gamma completa M5 - 1"
- Filettati e portagomma
- Compatibilità numerosi fluidi industriali
- Robustezza meccanica
- Versione attacchi a baionetta standard
- Silicon Free

### Applicazioni

- Aria Compressa
- Automazione Pneumatica
- Circuiti acqua industriale
- Gas inerti, vapore, fluidi
- Vuoto

Les adaptateurs en laiton nickelé offre un grand choix de configurations possibles. Aignep propose une large gamme de mamelons, réductions, bouchons, T, L, adaptateurs pour tuyaux.

Performances élevées en terme de pression et de température (+ 300 °C).  
Filetages BSPT, BSPP et métrique.

Les nourrices de distribution en aluminium et les silencieux complètent la gamme.

### Principaux avantages

- Gamme complète M5 - 1"
- Tous fluides compatibles
- Résistance mécanique
- Standard et raccords Baïonnettes
- Sans silicone

### Applications

- Air comprimé
- Automatismes pneumatiques
- Circuits d'eau industrielle
- Gaz neutres, vapeur
- Vide

Nickel-plated brass threaded adaptors is the argest range of Aignep.

Countless configurations in multiple sizes: nipples, reductions, plugs, T, L, hose adaptors.

High performances in pressure and temperatures (+300°C).

Sharp threads BSPT, BSPP & Metric.

Aluminium manifolds and silencers complete the range.

### Main advantages

- Complete Range M5 - 1"
- All Fluids compatible
- Mechanical Resistance
- Standard and Bayonet connection
- Silicon Free

### Applications

- Compressed Air
- Pneumatic Automation
- Industrial water circuits
- Inert Gases, Fluids, Steam
- Vacuum

Die Messing vernickelten Gewindeadapter von Aignep, komplettieren das umfangreiche Sortiment.

Unzählige Konfigurationen in verschiedenen Größen: Nippel, Reduzierungen, Stopfen, T- und L-Verschraubungen, Schlauchtüllen, etc. Hohe Leistungen im Druck- und Temperaturbereich (+ 300 °C).

Präzise Gewinde: BSPT, BSPP und metrisch. Verteilerblöcke aus Aluminium und Schalldämpfer runden das Angebot ab

### Hauptvorteile

- Vollständiges Sortiment M5 - 1"
- Kompatibel mit allen Medien
- Mechanische Festigkeit
- Standard and Bajonett Anschluss
- Silikonfrei

### Anwendungen

- Druckluft
- Pneumatische Automation
- Industrielle Wasserkreisläufe
- Inertgase, Flüssigkeiten, Dampf
- Vakuum

La serie de accesorios Aignep, completamente realizada en Latón niquelado, completa la oferta en términos de adaptadores, reducciones, tapones, y componentes para realizar de la mejor forma vuestras aplicaciones y circuitos.

Con importantes prestaciones en términos de presión y temperatura (+300°C), son realizados en una amplia gama base. Roscas BSPT, BSPP y Métricas.

Completan la gama una importante serie de regletas de distribución en aluminio y de silenciadores en bronce sinterizado y material plástico.

### Principales ventajas

- Gama completa M5-1" – roscados y espiga
- Compatibilidad con numerosos fluidos industriales
- Robustez mecánica
- Versión conexión a bayoneta standard
- Libres de silicona

### Aplicaciones

- Aire comprimido
- Automatización neumática
- Circuitos de agua industrial
- Gases inertes, vapor, fluidos
- Vacío

Accessórios roscados em latão niquelado é o maior range de itens da linha da Aignep.

Incontáveis configurações em diversos tamanhos: niples, reduções, plugs, T, L, Espiões para mangueiras.

Itens para alta pressão e alta temperatura (+300°C).

Roscas precisas: BSPT, BSPP & Métrica, manifolds em alumínio e silenciadores completas o range de produtos.

### Principais vantagens

- Completo Range de tamanhos : de M5 a 1"
- Compatível com todos os fluidos
- Resistência Mecânica
- Conexões do tipo standard e baioneta
- Livre de Silicone

### Aplicações

- Ar Comprimido
- Automação Pneumática
- Circuitos de Água Industrial
- Gases Inertes, Fluidos, Vapor
- Vácuo

**CARATTERISTICHE TECNICHE**

TECHNICAL CHARACTERISTICS  
 TECHNISCHE ANGABEN  
 CARACTÉRISTIQUES TECHNIQUES  
 CARACTERÍSTICAS TÉCNICAS  
 CARACTERÍSTICAS TÉCNICAS

**Norma di Riferimento**

Reference standard

Entspricht der Norm

Norme de référence

Normativa de referencia

Norma de referência

1907/2006

REACH ✓

2011/65/CE

ROHS ✓

PED  
2014/68/UE

SILICON  
FREE

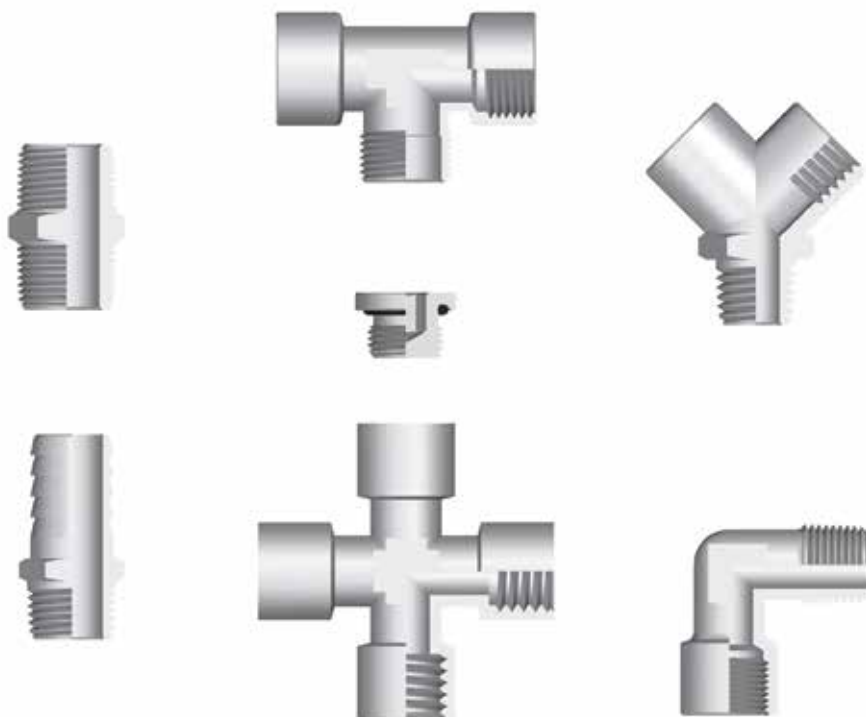
**Materiali e Componenti**
**IT**

La maggior parte degli articoli di questa serie è composta da un unico particolare in OT UNI EN 12164/5 CW 614/7N e subisce un trattamento galvanico di nichelatura.

Articoli prodotti in materiali diversi, verranno specificati all'interno del catalogo.

**Component Parts and Materials**
**GB**

The main part of these fittings is made in OT UNI EN 12164/5 CW 614/7N and undergo to a nickel-plating process.

Different materials will be specified in the catalogue.

**Komponenten und Materialien**
**DE**

Die meisten Artikel in dieser Serie werden aus OT UNI EN 12164/5 CW 614/7N hergestellt und werden einer Nickel Oberflächenbehandlung unterzogen.

Wenn Artikel mit anderen Materialien hergestellt sind, so wird das im Katalog direkt beim Produkt angegeben.

**Matériaux et Composants**
**FR**

La majeure partie des raccords de ce chapitre est fabriquée en laiton OT UNI EN 12164/5 CW 614/7N et traités par nickelage.

Les autres matériaux sont précisés dans le catalogue sous l'article concerné.

**Materiales y Componentes**
**ES**

La mayor parte de los artículos de esta serie está compuesta de un solo material latón (OT UNI EN 12164/5 CW 614/7N) sometido a un tratamiento galvanico de niquelatura.

Artículos producidos en materiales diversos, vendrán especificados al interior del catálogo.

**Materiais e Componentes**
**PT**

A maior parte dos itens desta série é fabricada em OT UNI EN 12164/5 CW 614/7N e passa por um tratamento galvânico de niquelamento.

Itens produzidos com materiais diferentes, estarão especificados no catálogo.



Misura  
Size  
Größe  
Dimensions  
Medida  
Tamanho

Pressione consigliata  
Pressure advised  
Empfohlener druck  
Pression conseillée  
Presión recomendada  
Pressão aconselhada

1/8	-0.99 bar ~ 150 bar
1/4	-0.99 bar ~ 100 bar
3/8	-0.99 bar ~ 75 bar
1/2	-0.99 bar ~ 50 bar
3/4	-0.99 bar ~ 85 bar
1"	-0.99 bar ~ 80 bar

**Temperature massima**

Maximum temperature

Maximum temperatur

Température maximale

Temperatura máxima

Temperatura máxima

+ 300 °C

**Fluidi compatibili**

Acqua / Olio / Aria compressa

Fluidi in genere per l'impiantistica idraulica, oleodinamica, idropneumatica, ecc.

**Fluids**

Water / Oils / Compressed air

Fluids in general for the hydraulic, pneumatic and oildynamic plants etc.

**Geeignete Medien**

Wasser / Oel / Druckluft

Medien im Allgemeinen für hydraulische-, hydropneumatische- und pneumatische Anlagen, usw.

**Fluides compatibles**

Eau / Huile / Air comprimé

Fluides courants utilisés en hydraulique et pneumatique, etc.

**Fluidos compatibles**

Agua / Aceite / Aire comprimido

Fluidos en general para los campos hidráulicos, neumáticos y oleodinámicos, etc.

**Fluidos compatíveis**

Água / Óleo / Ar comprimido

Fluidos em geral para aplicações hidráulicas, oleodinâmicas, hidropneumáticas, etc.

**Tubi di Collegamento**

IT

Tubi e raccordi in genere.

**Connection Tubes**

GB

Tubes and fittings in general.

**Geeignete Rohre**

DE

Rohre und Verschraubungen im Allgemeinen.

**Tubes Conseillés**

FR

Raccords et tubes compatibles.

**Tubos de Conexión**

ES

Tubo y racordaje en general.

**Tubos de Conexão**

PT

Tubos e conexões em geral.

**Filettatura**

IT

 Gas conica conforme ISO 7.1, BS 21, DIN 2999.  
 Gas cilindrica conforme ISO 228 Classe A.  
 Metrica conforme ISO R/262.  
 NPTF conforme ANSI B1.20.5

**Threads**

GB

 Tapered gas in conformity with ISO 7.1, BS 21, DIN 2999.  
 Parallel gas in conformity with ISO 228 Class A.  
 Metric in conformity with ISO R/262.  
 NPTF in conformity with ANSI B1.20.5

**Gewindearten**

DE

 Konisches Gewinde nach Norm ISO 7.1, BS 21, DIN 2999.  
 Zylindrisches Gewinde nach Norm ISO 228 Classe A.  
 Metrisches Gewinde nach Norm ISO R/262.  
 NPTF nach norm ANSI B1.20.5

**Filetages**

FR

 Filetage conique conforme: ISO 7.1, BS 21, DIN 2999.  
 Filetage cylindrique conforme: ISO 228 Class A.  
 Filetage métrique conforme: ISO R/262.  
 NPTF conforme: ANSI B1.20.5

**Roscas**

ES

 Gas cónica conforme ISO 7.1, BS 21, DIN 2999.  
 Gas cilíndrica conforme ISO 228 Clase A.  
 Métrica conforme ISO R/262.  
 NPTF conforme ANSI B1.20.5

**Roscas**

PT

 Gas cônica conforme ISO 7.1, BS 21, DIN 2999.  
 Gas paralela conforme ISO 228 Classe A.  
 Métrica conforme ISO R/262.  
 NPTF conforme ANSI B1.20.5

## 2000

### NIPPLO CONICO

NIPPLE (TAPER)  
 DOPPELNIPPEL KONISCH  
 MAMELON DOUBLE CONIQUE  
 MACHÓN CÓNICO  
 NIPLE COM ROSCA CÔNICA

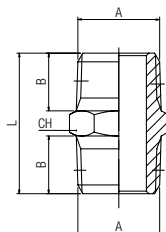

Code	A	B	L	CH	Pack.
02000 00 01 02 NB	1/8	7.5	19.5	12	10
02000 00 01 03 NB	1/4	11	27	14	10
02000 00 01 04 NB	3/8	11.5	28	17	10
02000 00 01 05 NB	1/2	14	33.5	22	10
02000 00 01 07 NB	3/4	16.5	40	27	10
02000 00 01 09 NT	1"	19	46.5	34	10

## 2010

### NIPPLO CILINDRICO

NIPPLE (PARALLEL)  
 DOPPELNIPPEL ZYLINDRISCH  
 MAMELON DOUBLE, CYLINDRIQUE  
 MACHÓN CILÍNDRICO  
 NIPLE COM ROSCA PARALELA

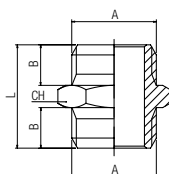

Code	A	B	L	CH	Pack.
02010 00 01 PG NB	M3	2.8	10	5	10
02010 00 01 B5 NB	M5	4	11.5	8	10
02010 00 01 02 NB	1/8	6	16.5	14	10
02010 00 01 03 NB	1/4	8	21	17	10
02010 00 01 04 NB	3/8	9	23	19	10
02010 00 01 05 NB	1/2	10	25.5	24	10
02010 00 01 07 NB	3/4	12	29.5	30	10
02010 00 01 09 NB	1"	12	32	40	10

## 2020

### NIPPLO DI RIDUZIONE CONICO

REDUCING NIPPLE (TAPER)  
 DOPPELNIPPEL REDUZIERT KONISCH  
 MAMELON DOUBLE INÉGAL, CONIQUE  
 MACHÓN CÓNICO DE REDUCCIÓN  
 NIPLE DE REDUÇÃO COM ROSCA CÔNICA

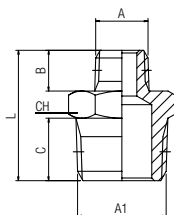
**New**

Code	A	A1	B	C	L	CH	Pack.
02020 00 01 AT NB	1/8	1/4	7.5	11	23.5	14	10
02020 00 01 3W NB	1/8	3/8	7.5	11.5	24	17	10
02020 00 01 4W NB	1/8	1/2	7.5	14	27	22	10
02020 00 01 7W NB	1/4	3/8	11	11.5	27.5	17	10
02020 00 01 8W NB	1/4	1/2	11	14	30.5	22	10
02020 00 01 ED NB	1/4	3/4	11	16.5	34.5	27	10
02020 00 01 AC NB	3/8	1/2	11.5	14	31	22	10
02020 00 01 AL NB	3/8	3/4	11.5	16.5	35	27	10
02020 00 01 AH NB	1/2	3/4	14	16.5	37.5	27	10
02020 00 01 AP NT	1/2	1"	14	19	41.5	34	10
02020 00 01 AS NT	3/4	1"	16.5	19	44	34	10

## 2030

### NIPPLO DI RIDUZIONE CILINDRICO

REDUCING NIPPLE (PARALLEL)  
 DOPPELNIPPEL REDUZIERT ZYLINDRISCH  
 MAMELON DOUBLE INÉGAL, CYLINDRIQUE  
 MACHÓN CILÍNDRICO DE REDUCCIÓN  
 NIPLE DE REDUÇÃO COM ROSCAPARALELA

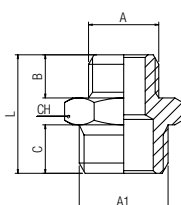

Code	A	A1	B	C	L	CH	Pack.
02030 00 01 0W NB	M5	1/8	4	6	14.5	14	10
02030 00 01 AT NB	1/8	1/4	6	8	19	17	10
02030 00 01 3W NB	1/8	3/8	6	9	20	19	10
02030 00 01 7W NB	1/4	3/8	8	9	22	19	10
02030 00 01 8W NB	1/4	1/2	8	10	23.5	24	10
02030 00 01 AC NB	3/8	1/2	9	10	24.5	24	10
02030 00 01 AH NT	1/2	3/4	10	12	27.5	30	10

## 2040

### RIDUZIONE CONICA

REDUCER (TAPER)  
 VERGRÖßERUNG KONISCH  
 GROSSISSEUR, CONIQUE  
 UNIÓN CÓNICA MACHO - HEMBRA  
 REDUÇÃO COM ROSCA CÔNICA

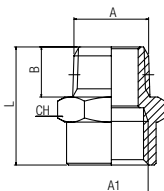

Code	A	A1	B	L	CH	Pack.
02040 00 01 2W NB	1/8	1/8	7.5	20	14	10
02040 00 01 AT NB	1/8	1/4	7.5	22	17	10
02040 00 01 3W NB	1/8	3/8	7.5	23	22	10
02040 00 01 6W NB	1/4	1/4	11	26	17	10
02040 00 01 7W NB	1/4	3/8	11	27	22	10
02040 00 01 8W NB	1/4	1/2	11	30	26	10
02040 00 01 AB NB	3/8	3/8	11.5	27.5	22	10
02040 00 01 AC NB	3/8	1/2	11.5	30.5	26	10
02040 00 01 AL NB	3/8	3/4	11.5	32.5	32	10
02040 00 01 AG NB	1/2	1/2	14	33	26	10
02040 00 01 AH NB	1/2	3/4	14	35	32	10
02040 00 01 AS NB	3/4	1"	16.5	41	41	10

## 2050

### RIDUZIONE CILINDRICA

REDUCER (PARALLEL)  
 VERGRÖßERUNG ZYLINDRISCH  
 GROSSISSEUR, CYLINDRIQUE  
 UNIÓN CILÍNDRICA MACHO - HEMBRA  
 REDUÇÃO COM ROSCA PARALELA

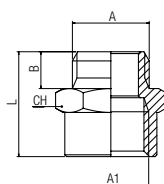

**New**

Code	A	A1	B	L	CH	Pack.
02050 00 01 0W NB	M5	1/8	4	14.5	14	10
02050 00 01 2W NB	1/8	1/8	6	17	14	10
02050 00 01 AT NB	1/8	1/4	6	20.5	17	10
02050 00 01 3W NB	1/8	3/8	6	21.5	22	10
02050 00 01 6W NB	1/4	1/4	8	22.5	17	10
02050 00 01 7W NB	1/4	3/8	8	23.5	22	10
02050 00 01 8W NB	1/4	1/2	8	26.5	26	10
02050 00 01 AB NB	3/8	3/8	9	24.5	22	10
02050 00 01 AC NB	3/8	1/2	9	27.5	26	10
02050 00 01 AL NB	3/8	3/4	9	30	32	10
02050 00 01 AG NB	1/2	1/2	10	28.5	26	10
02050 00 01 AH NB	1/2	3/4	10	31	32	10

## 2060

### NIPPLE CONICO ORIENTABILE (3 PEZZI)

TAPER NIPPLE (3 PIECES)  
 DOPPELNIPPEL KONISCH EINSTELLBAR (3 STÜCK)  
 MAMELON DOUBLE 3 PIÈCES  
 MACHÓN CÓNICO ORIENTABLE (3 PIEZAS)  
 NIPLÉ ORIENTÁVEL COM ROSCA CÔNICA (3 PARTES)

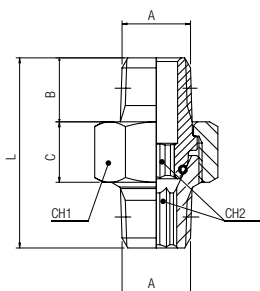
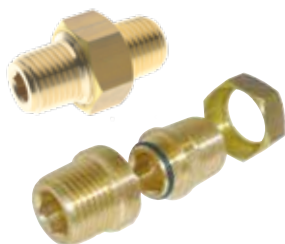

Code	A	B	C	D	L	CH1	CH2	*	Pack.
02060 00 001	1/8	9	8.5	7.5	27	15	5	15	10
02060 00 002	1/4	11.5	9.5	11	33.5	19	6	15	10
02060 00 003	3/8	13	10	11.5	36.5	22	8	20	10
02060 00 004	1/2	16	12	14	45	27	12	20	10
02060 00 005	3/4	18	17	16.5	54	36	14	40	5
02060 00 006	1"	21.5	20	19	65	46	19	40	1

Articolo non nichelato.  
 Article not nickel-plated.  
 Artikel nicht vernickelt.  
 Article non nickelé.  
 Artículo no niquelado.  
 Item não niquelado.

\* Coppia di serraggio (Nm).  
 Torque specifications (Nm).  
 Angaben Drehmoment (Nm).  
 Couple de serrage (Nm).  
 Par de apriete (Nm).  
 Torque de aperto (Nm).

	min	max
<b>Temperature</b>	- 20 °C	+ 80 °C
<b>Pressure</b>	- 0.99 bar (-0.099 MPa)	+ 50 bar (5 MPa)

## 2070

### PROLUNGA CILINDRICA

EXTENSION (PARALLEL)  
 VERLÄNGERUNG ZYLINDRISCH  
 RALLONGE ÉGALE, CYLINDRIQUE  
 PROLONGACIÓN CILÍNDRICA  
 PROLONGAMENTO COM ROSCA PARALELA

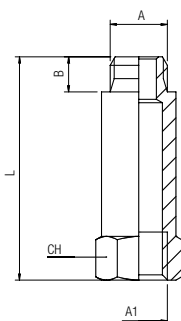

Code	A	A1	L	B	CH	Pack.
02070 00 01 YN NB	M5	M5	18.5	4	7	10
02070 00 01 BH NB	1/8	1/8	22	6	14	10
02070 00 01 UP NB	1/8	1/8	32	6	14	10
02070 00 01 BI NB	1/8	1/8	42	6	14	10
02070 00 01 UQ NB	1/8	1/8	51	6	14	10
02070 00 01 UR NB	1/4	1/4	28	8	17	10
02070 00 01 BL NB	1/4	1/4	35	8	17	10
02070 00 01 BM NB	1/4	1/4	51	8	17	10
02070 00 01 UT NB	3/8	3/8	32	9	22	10
02070 00 01 US NB	1/2	1/2	35	10	26	10

## 2080

### RIDUZIONE CONICA

REDUCER (TAPER)  
 REDUZIERUNG KONISCH  
 RÉDUCTION, CONIQUE  
 REDUCCIÓN CÓNICA  
 REDUÇÃO COM ROSCA CÔNICA

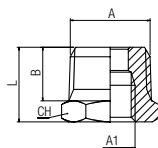

Code	A	A1	B	L	CH	Pack.
02080 00 01 5W NB	1/4	1/8	11	16	14	10
02080 00 01 9W NB	3/8	1/8	11.5	16.5	17	10
02080 00 01 AD NB	1/2	1/8	14	19.5	22	10
02080 00 01 AA NB	3/8	1/4	11.5	16.5	17	10
02080 00 01 AE NB	1/2	1/4	14	19.5	22	10
02080 00 01 AF NB	1/2	3/8	14	19.5	22	10
02080 00 01 AL NB	3/4	3/8	16.5	23.5	27	10
02080 00 01 AM NB	3/4	1/2	16.5	23.5	27	10
02080 00 01 AP NT	1"	1/2	19	27.5	34	10
02080 00 01 AQ NT	1"	3/4	19	27.5	34	10
02080 00 01 AR NT	1 1/4"	1/2	22	31	45	10
02080 00 01 AU NT	1 1/4"	3/4	22	31	45	10
02080 00 01 AV NT	1 1/4"	1"	22	31	45	10
02080 00 01 82 NT	1 1/2"	1"	22	32	50	5
02080 00 01 83 NT	2"	1"	24	36	60	5

## 2090

### RIDUZIONE CILINDRICA

REDUCER (PARALLEL)  
 REDUZIERUNG ZYLINDRISCH  
 RÉDUCTION, CYLINDRIQUE  
 REDUCCIÓN CILÍNDRICA  
 REDUÇÃO COM ROSCA PARALELA

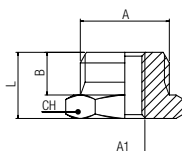

Code	A	A1	B	L	CH	Pack.
02090 00 01 YP NB	M5	M3	4	6.5	7	10
02090 00 01 OW NT	1/8	M5	6	10.5	14	10
02090 00 01 4W NB	1/4	M5	8	13	17	10
02090 00 01 5W NT	1/4	1/8	8	13	17	10
02090 00 01 9W NT	3/8	1/8	9	14	19	10
02090 00 01 AD NT	1/2	1/8	10	15.5	24	10
02090 00 01 AA NT	3/8	1/4	9	14	19	10
02090 00 01 AE NT	1/2	1/4	10	15.5	24	10
02090 00 01 AF NT	1/2	3/8	10	15.5	24	10
02090 00 01 ED NB	3/4	1/4	12	17.5	30	10
02090 00 01 AL NT	3/4	3/8	12	17.5	30	10
02090 00 01 AM NT	3/4	1/2	12	17.5	30	10
02090 00 01 AP NB	1"	1/2	12	20	40	10
02090 00 01 AQ NB	1"	3/4	12	20	40	10



## 2092

### RIDUZIONE CILINDRICA CON O-RING NBR

REDUCER (PARALLEL) WITH NBR O-RING  
 REDUZIERUNG ZYLINDRISCH MIT NBR O-RING  
 RÉDUCTION CYLINDRIQUE AVEC JOINT TORIQUE NBR  
 REDUCCIÓN CILÍNDRICA CON TORICA NBR  
 REDUÇÃO COM ROSCA PARALELA COM ROSCA PARALELA E O-RING NBR

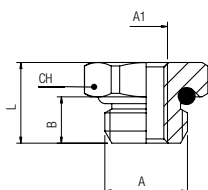

Code	A	A1	B	L	CH	R	C	Pack.
02092 00 012	M7	M5	5	12	10	4	0.8	10
02092 00 001	1/8	M5	5.4	9.4	13	8	3	10
02092 00 008	1/4	M5	7	11	16	20	6	10
02092 00 002	1/4	1/8	5.5	11.1	16	20	6	10
02092 00 003	3/8	1/8	6.5	12.6	20	70	10	10
02092 00 004	3/8	1/4	6.5	12.6	20	40	9	10
02092 00 009	1/2	1/8	9.5	14.5	25	130	12	10
02092 00 005	1/2	1/4	9.6	14.6	25	130	12	10
02092 00 006	1/2	3/8	9.6	14.6	25	110	12	10
02092 00 010	3/4	1/4	11	16	34	130	12	10
02092 00 011	3/4	3/8	11	16	34	130	12	10
02092 00 007	3/4	1/2	11.1	16	34	110	12	10

R = Coppia di rottura (Nm)  
 Breaking Torque (Nm)  
 Abscherdrehmoment (Nm)  
 Couple de Rupture (Nm)  
 Par de Rotura (Nm)  
 Torque de Ruptura (Nm)

C = Coppia consigliata (Nm)  
 Recommended Torque (Nm)  
 Empfohlenes Drehmoment (Nm)  
 Couple de Serrage (Nm)  
 Par Aconsejado (Nm)  
 Torque Recomendado (Nm)

	min	max
Temperature	- 20 °C	+ 80 °C

## 2095

### RIDUZIONE CILINDRICA

REDUCER (PARALLEL)  
 REDUZIERUNG ZYLINDRISCH  
 RÉDUCTION, CYLINDRIQUE  
 REDUCCIÓN CILÍNDRICA  
 REDUÇÃO COM ROSCA PARALELA

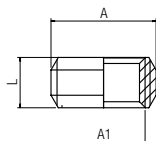

Code	A	A1	L	Pack.
02095 00 01 5W 00	1/4	1/8	8	10
02095 00 01 AA 00	3/8	1/4	9	10
02095 00 01 AF 00	1/2	3/8	10	10
02095 00 01 AM 00	3/4	1/2	14	10
02095 00 01 AQ 00	1"	3/4	20	10

Articolo non nichelato.  
 Article not nichel-plated.  
 Artikel nicht vernickelt.  
 Article non nickelé.  
 Artículo no niquelado.  
 Item não niquelado.

## 2096

### GHIERA

NUT  
 MUTTER  
 ÉCROU  
 TUERCA  
 PORCA

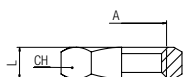

Code	A	L	CH	Pack.
02096 00 01 02 NB	1/8	4.5	14	50
02096 00 01 03 NB	1/4	5	17	50
02096 00 01 04 NB	3/8	6	20	50
02096 00 01 05 NB	1/2	6	24	50

## 2110

### NIPPLO CONICO ORIENTABILE

ORIENTING NIPPLE (TAPER)  
 SCHWENKNIPPEL KONISCH  
 MAMELON ORIENTABLE, CONIQUE  
 UNIÓN CÓNICA ORIENTABLE  
 NIPLE ORIENTÁVEL COM ROSCA CÔNICA

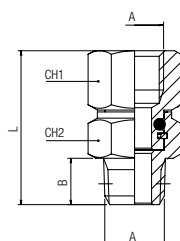

Code	A	B	CH1	CH2	L	Pack.
02110 00 001	1/8	7.5	13	13	25	10
02110 00 002	1/4	11	16	15	33	10
02110 00 003	3/8	11.5	20	17	35.5	10

	min	max
Temperature	- 20 °C	+ 80 °C
Pressure	- 0.99 bar (-0.099 MPa)	+ 15 bar (1.5 MPa)

## 2115

### NIPPLO CILINDRICO ORIENTABILE

ORIENTING NIPPLE (PARALLEL)  
 SCHWENKNIPPEL ZYLINDRISCH  
 MAMELON ORIENTABLE, CYLINDRIQUE  
 UNIÓN CILÍNDRICA ORIENTABLE CON TÓRICA  
 NIPLE ORIENTÁVEL COM ROSCA PARALELA

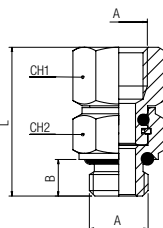

Code	A	B	CH1	CH2	L	Pack.
02115 00 001	1/8	6	13	13	24.5	10
02115 00 002	1/4	8	16	16	31	10
02115 00 003	3/8	9	20	18	34.5	10

	min	max
<b>Temperature</b>	- 20 °C	+ 80 °C
<b>Pressure</b>	- 0.99 bar (-0.099 MPa)	+ 15 bar (1.5 MPa)

## 2116

### NIPPLO MASCHIO CILINDRICO ORIENTABILE CON OR

MALE ORIENTING NIPPLE WITH OR (PARALLEL)  
 DOPPELNIPPEL ZYLINDRISCH EINSTELLBAR  
 MAMELON DOUBLE ORIENTABLE BSPP AVEC JOINT TORIQUE  
 UNIÓN MACHO CILÍNDRICO ORIENTABLE CON OR  
 NIPLE MACHO ROSCA PARALELA ORIENTÁVEL COM O-RING

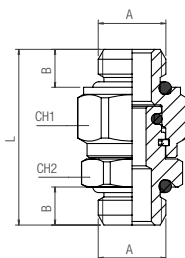

Code	A	B	L	CH1	CH2	Pack.
02116 GI 001	1/8	5.5	25	14	13	10
02116 GI 002	1/4	7	29	17	16	10
02116 GI 003	3/8	8	33	20	20	10
02116 GI 004	1/2	9.5	37	25	25	10
02116 GI 005	3/4	11	48.5	34	34	10
02116 GI 006	1"	12	52	40	40	10

Articolo non nichelato.  
 Article not nichel-plated.  
 Artikel nicht vernickelt.  
 Article non nickelé.  
 Artículo no niquelado.  
 Item não niquelado.

	min	max
<b>Temperature</b>	- 20 °C	+ 80 °C

## 3000

### MANICOTTO

SLEEVE  
 MUFFE  
 MANCHON  
 MANGUITO  
 LUYA

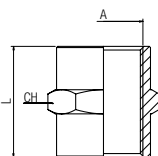

Code	A	L	CH	Pack.
03000 00 01 B5 NB M5	M5	11	8	10
03000 00 01 02 NB 1/8	1/8	15	14	10
03000 00 01 03 NB 1/4	1/4	22	17	10
03000 00 01 04 NB 3/8	3/8	24	22	10
03000 00 01 05 NB 1/2	1/2	30	26	10
03000 00 01 07 NB 3/4	3/4	32	32	10
03000 00 01 09 NB 1"	1"	46	40	10

## 3010

### MANICOTTO DI RIDUZIONE

REDUCING SLEEVE  
 MUFFE REDUZIERT  
 MANCHON INÉGAL  
 MANGUITO DE REDUCCIÓN  
 LUYA DE REDUÇÃO

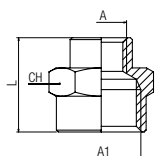

Code	A	A1	L	CH	Pack.
03010 00 01 0W NB M5 1/8	M5	1/8	13	14	10
03010 00 01 AT NB 1/8 1/4	1/8	1/4	19	17	10
03010 00 01 3W NB 1/8 3/8	1/8	3/8	20	22	10
03010 00 01 4W NB 1/8 1/2	1/8	1/2	24	24	10
03010 00 01 7W NB 1/4 3/8	1/4	3/8	23	22	10
03010 00 01 8W NB 1/4 1/2	1/4	1/2	25	24	10
03010 00 01 AC NB 3/8 1/2	3/8	1/2	27.5	24	10
03010 00 01 AH NB 1/2 3/4	1/2	3/4	30	30	10
03010 00 01 AI NB 1/2 1"	1/2	1"	39	40	10
03010 00 01 AS NB 3/4 1"	3/4	1"	41	40	10

### 3015

**TAPPO MASCHIO CILINDRICO ESAGONO INCASSATO CON O-RING NBR**  
 MALE PLUG (PARALLEL) WITH EXAGON EMBEDDED AND NBR O-RING  
 GEWINDESTOPFEN ZYLINDRISCH INNENSECHSKANT MIT O-RING NBR  
 BOUCHON À 6 PANS CREUX MÂLE, CYLINDRIQUE AVEC JOINT NBR  
 TAPÓN MACHO CILÍNDRICO HEXÁGONO INTERIOR CON TÓRICA NBR  
 TAMPÃO MACHO COM ROSCA PARALELA E SEXTAVADO INTERNO (O-RING EM NBR)

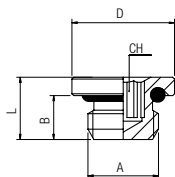

Code	A	B	L	D	CH	Pack.
03015 00 005	M5	4	6	8	2	10
03015 00 011	M7x1	5	7.5	9.5	3	10
03015 00 006	M8x1	5.4	8	12	4	10
03015 00 007	M10x1	6	8.5	14	5	10
03015 00 001	1/8	6	8.5	14	5	10
03015 00 002	1/4	8	11	17	6	10
03015 00 008	M12x1,25	8	11	15	6	10
03015 00 003	3/8	9	12.5	20	8	10
03015 00 004	1/2	10	13.5	25	10	10
03015 00 009	3/4	11.1	15.5	34	17	10
03015 00 010	1"	11.8	16	38	19	10

	min	max
Temperature	- 20 °C	+ 80 °C

### 3015V

**TAPPO MASCHIO CILINDRICO ESAGONO INCASSATO CON O-RING FKM**  
 MALE PLUG (PARALLEL) WITH EXAGON EMBEDDED AND FKM O-RING  
 GEWINDESTOPFEN ZYLINDRISCH INNENSECHSKANT MIT O-RING FKM  
 BOUCHON À 6 PANS CREUX MÂLE, CYLINDRIQUE AVEC JOINT FKM  
 TAPÓN MACHO CILÍNDRICO HEXÁGONO INTERIOR CON TÓRICA FKM  
 TAMPÃO MACHO COM ROSCA PARALELA E SEXTAVADO INTERNO (O-RING EM FKM)

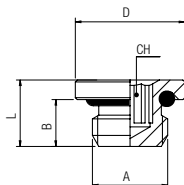

Code	A	B	L	D	CH	Pack.
03015 V0 005	M5	4	6	8	2	10
03015 V0 001	1/8	6	8.5	14	5	10
03015 V0 002	1/4	8	11	17	6	10
03015 V0 003	3/8	9	12.5	20	8	10
03015 V0 004	1/2	10	13.5	25	10	10

	min	max
Temperature	- 15 °C	+ 200 °C

**EPDM** Guarnizioni EPDM a richiesta - EPDM Seals are available upon request - Auf Anfrage EPDM O-Ring  
 Dichtung - Joint EPDM en sur demande - Bajo EPDM demanda. Junta - Vedação EPDM de sob encomenda

### 3020

**TAPPO MASCHIO CILINDRICO**  
 MALE PLUG (PARALLEL)  
 GEWINDESTOPFEN ZYLINDRISCH  
 BOUCHON À 6 PANS MÂLE, CYLINDRIQUE  
 TAPÓN MACHO CILÍNDRICO  
 TAMPÃO MACHO COM ROSCA PARALELA

**New**

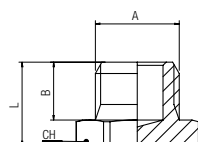

Code	A	B	L	CH	Pack.
03020 00 01 B5 NB	M5*	4.5	8	8	10
03020 00 01 B8 NB	M6x1	4.5	8	10	10
03020 00 01 NQ NB	M8x1,25	5.4	9.4	12	10
03020 00 01 JG NB	M10x1	5.4	9.4	14	10
03020 00 01 02 NB	1/8	6.5	10	14	10
03020 00 01 03 NB	1/4	9	13	17	10
03020 00 01 RL NB	M12x1	8	12	16	10
03020 00 01 D5 NB	M12x1,25	9	13	16	10
03020 00 01 04 NB	3/8	9.5	13.5	19	10
03020 00 01 05 NB	1/2	10	14.5	24	10
03020 00 01 07 NB	3/4	11	16	30	10
03020 00 01 09 NB	1"	12	17	40	10

\* Installabile anche con cacciavite  
 Can be also installed with a screwdriver  
 Kann auch mit einem Schraubendreher angebracht werden  
 Peut être installé avec un tournevis  
 Se puede instalar con destornillador  
 Pode ser instalado com chave de fenda

### 3021

**TAPPO MASCHIO CONICO**  
 MALE PLUG (TAPER)  
 GEWINDESTOPFEN KONISCH  
 BOUCHON À 6 PANS MÂLE, CÓNIQUE  
 TAPÓN MACHO CÓNICO  
 TAMPÃO MACHO CÔNICA

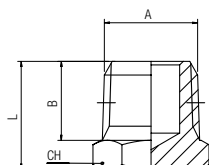

Code	A	B	L	CH	Pack.
03021 00 01 02 NB	1/8	7.5	11	10	10
03021 00 01 03 NB	1/4	11	15	14	10
03021 00 01 04 NB	3/8	11.5	15.5	17	10
03021 00 01 05 NB	1/2	14	18.5	22	10
03021 00 01 07 NB	3/4	16.5	21.5	27	10
03021 00 01 09 NB	1"	19	25	34	10

## 3025

### TAPPO MASCHIO CONICO

MALE PLUG (TAPER)

GEWINDESTOPFEN KONISCH

BOUCHON À 6 PANS CREUX, CONIQUE

TAPÓN MACHO CÓNICO HEXÁGONO INTERIOR

TAMPÃO MACHO COM ROSCA CÔNICA

Code	A	B	H	CH	Pack.
03025 00 01 02 NB	1/8	7.5	5	5	10
03025 00 01 03 NB	1/4	10	7	6	10
03025 00 01 04 NB	3/8	11	7	8	10
03025 00 01 05 NB	1/2	13	8	10	10

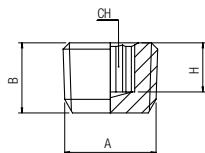

## 3026

### TAPPO MASCHIO CILINDRICO

MALE PLUG (PARALLEL)

GEWINDESTOPFEN ZYLINDRISCH

BOUCHON À 6 PANS CREUX, CYLINDRIQUE

TAPÓN MACHO CILÍNDRICO HEXÁGONO INTERIOR

TAMPÃO MACHO COM ROSCA PARALELA

Code	A	B	D	E	H	CH	Pack.
03026 00 01 02 NB	1/8	8	8	2	5	5	10
03026 00 01 03 NB	1/4	11	11	3	7	6	10
03026 00 01 04 NB	3/8	12.5	14.5	3.5	8.5	8	10
03026 00 01 05 NB	1/2	14	18	4	10	10	10
03026 00 01 07 NB	3/4	14	21.5	3	10	12	10

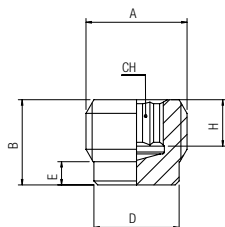

## 3030

### TAPPO FEMMINA

FEMALE PLUG

STOPFEN INNENGEW.

BOUCHON FEMELLE

TAPÓN HEMBRA

TAMPÃO COM ROSCA FÊMEA

Code	A	B	L	CH	Pack.
03030 00 01 02 NB	1/8	7.5	11	12	10
03030 00 01 03 NB	1/4	11	19	14	10
03030 00 01 04 NB	3/8	11.5	20	17	10
03030 00 01 05 NB	1/2	14	22	19	10

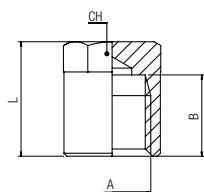

**3040**

**PORTAGOMMA MASCHIO CONICO**

MALE HOSE ADAPTER (TAPER)

SCHLAUCHTÜLLE AUSSENGEW. KONISCH

DOUILLE ANNELÉE, CONIQUE

ESPIGA MACHO CÓNICA

ESPIGÃO COM ROSCA MACHO CÔNICA

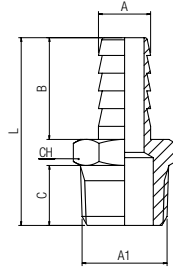

Code	A	A1	B	C	L	CH	Pack.
03040 00 01 BQ NB	4	1/8	19.5	7.5	32	12	10
03040 00 01 BS NB	6	1/8	19.5	7.5	32	12	10
03040 00 01 BT NB	6	1/4	19.5	11	35.5	14	10
03040 00 01 BZ NB	7	1/8	19.5	7.5	32	12	10
03040 00 01 BX NB	7	1/4	19.5	11	35.5	14	10
03040 00 01 BY NB	8	1/8	19.5	7.5	32	12	10
03040 00 01 BJ NB	8	1/4	19.5	11	35.5	14	10
03040 00 01 BK NB	8	3/8	19.5	11.5	36	17	10
03040 00 01 CA NB	9	1/8	19.5	7.5	32	12	10
03040 00 01 CB NB	9	1/4	19.5	11	35.5	14	10
03040 00 01 CC NB	9	3/8	19.5	11.5	36	17	10
03040 00 01 CD NB	9	1/2	19.5	14	39	22	10
03040 00 01 CE NB	10	1/8	19.5	7.5	32	12	10
03040 00 01 CF NB	10	1/4	19.5	11	35.5	14	10
03040 00 01 CG NB	10	3/8	19.5	11.5	36	17	10
03040 00 01 CH NB	10	1/2	19.5	14	39	22	10
03040 00 01 VB NB	11	1/8	19.5	7.5	32	12	10
03040 00 01 RP NB	11	1/4	19.5	11	35.5	14	10
03040 00 01 QR NB	11	3/8	19.5	11.5	36	17	10
03040 00 01 VF NB	11	1/2	19.5	14	39	17	10
03040 00 01 CI NB	12	1/4	19.5	11	35.5	14	10
03040 00 01 CL NB	12	3/8	19.5	11.5	36	17	10
03040 00 01 CM NB	12	1/2	19.5	14	39	22	10
03040 00 01 CN NB	14	3/8	19.5	11.5	36	17	10
03040 00 01 DB NB	14	1/2	19.5	14	39	22	10
03040 00 01 5P NB	15	1/4	19.5	11	35.5	22	10
03040 00 01 1G NB	15	3/8	19.5	11.5	36	17	10
03040 00 01 CP NB	15	1/2	19.5	14	39	22	10
03040 00 01 VG NB	15	3/4	19.5	14.5	43.5	27	10
03040 00 01 CQ NB	16	3/8	19.5	11.5	36	17	10
03040 00 01 CR NB	16	1/2	19.5	14	39	22	10
03040 00 01 CS NB	16	3/4	19.5	16.5	43.5	27	10
03040 00 01 CT NB	17	3/8	19.5	11.5	36	18	10
03040 00 01 CU NB	17	1/2	19.5	14	39	22	10
03040 00 01 CV NB	18	3/8	19.5	11.5	36	19	10
03040 00 01 CZ NB	18	1/2	19.5	14	39	22	10
03040 00 01 CX NB	18	3/4	19.5	16.5	43.5	27	10
03040 00 01 R7 NB	20	3/8	19.5	11.5	36	21	10
03040 00 01 C1 NB	20	1/2	30	14	49.5	22	10
03040 00 01 R8 NB	20	3/4	30	13.5	50.5	27	10
03040 00 01 VC NB	21	3/8	30	11.5	47.5	22	10
03040 00 01 VH NB	21	1/2	30	14	49.5	22	10
03040 00 01 VI NB	21	3/4	30	14.5	54	27	10
03040 00 01 C4 NB	25	3/4	30	14.5	51.5	27	10
03040 00 01 DL NB	25	1"	30	16	53.5	34	10
03040 00 01 VD NB	27	3/4	30	14.5	52.5	28	10
03040 00 01 UL NB	27	1"	30	16	53.5	34	10
03040 00 01 VE NB	34	1"	30	16	55	36	10

## 3044

### PORTAGOMMA MASCHIO CILINDRICO CON O-RING

MALE HOSE ADAPTER (PARALLEL) WITH O-RING

SCHLAUCHTÜLLE AUSSENGEW. ZYLINDRISCH MIT O-RING

DOUILLE ANNELÉE, CYLINDRIQUE AVEC JOINT TORIQUE

ESPIGA MACHO CILÍNDRICA CON TÓRICA

ESPIGAO COM ROSCA MACHO PARALELA E O-RING

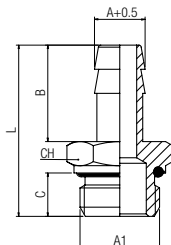

Code	A	A1	B	C	L	CH	Pack.
03044 00 001	4.5	M5	15	4	24	8	10
03044 00 023	6	1/4	20	8	34.5	16	10
03044 00 002	7	1/8	20	6	31	13	10
03044 00 003	7	1/4	20	8	34.5	16	10
03044 00 004	8	1/8	20	6	31	13	10
03044 00 005	8	1/4	20	8	34.5	16	10
03044 00 024	8	3/8	20	9	35.5	19	10
03044 00 015	8	1/2	20	10	37.5	24	10
03044 00 006	9	1/8	20	6	31	13	10
03044 00 007	9	1/4	20	8	34.5	16	10
03044 00 008	9	3/8	20	9	35.5	19	10
03044 00 025	10	1/4	20	8	34.5	16	10
03044 00 026	10	3/8	24	9	39.5	19	10
03044 00 027	10	1/2	22	10	39.5	24	10
03044 00 009	12	1/4	20	8	34.5	16	10
03044 00 010	12	3/8	20	9	35.5	19	10
03044 00 011	12	1/2	22	10	39.5	24	10
03044 00 016	13	1/2	22	10	39.5	24	10
03044 00 028	14	1/4	24	8	38.5	16	10
03044 00 020	14	3/8	24	9	39.5	19	10
03044 00 021	14	1/2	24	10	41.5	24	10
03044 00 012	17	3/8	24	9	39.5	19	10
03044 00 013	17	1/2	24	10	41.5	24	10
03044 00 017	19	3/4	30	11.1	49	33	10
03044 00 022	20	3/4	35	11	54	33	10
03044 00 018	25	1"	30	11.8	49.7	37	10
03044 00 019	27	1"	30	11.8	49.7	37	10

min

max



Temperature

- 20 °C

+ 80 °C

## 3045

### PORTAGOMMA MASCHIO CILINDRICO

MALE HOSE ADAPTER (PARALLEL)

SCHLAUCHTÜLLE AUSSENGEW. ZYLINDRISCH

DOUILLE ANNELÉE, CYLINDRIQUE

ESPIGA MACHO CILÍNDRICA

ESPIGAO COM ROSCA MACHO PARALELA

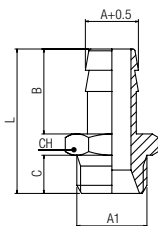

Code	A	A1	B	C	L	CH	Pack.
03045 00 01 6Q NB	3	M5	7.5	4	15.5	8	10
03045 00 01 BQ NB	4	1/8	15	6	30	14	10
03045 00 01 8S NB	4.5	M5	15	4	23	8	10
03045 00 01 BS NB	6	1/8	20	6	30	14	10
03045 00 01 BT NB	6	1/4	20	8	33	17	10
03045 00 01 BZ NB	7	1/8	20	6	30	14	10
03045 00 01 BX NB	7	1/4	20	8	33	17	10
03045 00 01 BY NB	8	1/8	20	6	30	14	10
03045 00 01 BJ NB	8	1/4	20	8	33	17	10
03045 00 01 CA NB	9	1/8	20	6	30	14	10
03045 00 01 CB NB	9	1/4	20	8	33	17	10
03045 00 01 CC NB	9	3/8	20	9	34	19	10
03045 00 01 CD NB	9	1/2	20	10	35.5	24	10
03045 00 01 VB NB	11	1/8	20	6	30	14	10
03045 00 01 RP NB	11	1/4	20	8	33	17	10
03045 00 01 QR NB	11	3/8	20	9	34	19	10
03045 00 01 VF NB	11	1/2	20	20	35.5	24	10
03045 00 01 CI NB	12	1/4	20	8	33	17	10
03045 00 01 CL NB	12	3/8	20	9	34	19	10
03045 00 01 CM NB	12	1/2	22	10	37.5	24	10
03045 00 01 5P NB	15	1/4	20	8	33	17	10
03045 00 01 1G NB	15	3/8	20	8	34	19	10
03045 00 01 CP NB	15	1/2	22	10	37.5	24	10
03045 00 01 VG NB	15	3/4	22	12	39.5	30	10
03045 00 01 CT NB	17	3/8	24	9	38	19	10
03045 00 01 CU NB	17	1/2	24	10	39.5	24	10
03045 00 01 TA NB	19	3/4	24	12	41.5	30	10
03045 00 01 VI NB	21	3/4	24	12	41.5	30	10

### 3047

#### PORTAGOMMA INTERMEDIO

STRAIGHT HOSE ADAPTOR  
 VERBINDUNGSVERSCHRAUBUNG MIT SCHLAUCHTÜLLEN  
 DOUILLE ANNELÉE DE JONCTION  
 EPIGA DOBLE  
 CONEXÃO ESPIGÃO RETA

**New**

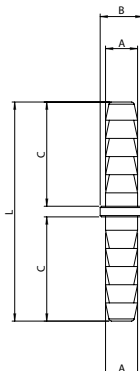

Code	A	B	C	L	Pack.
03047 00 01 X4 NB	6	8	19.5	41	10
03047 00 01 X7 NB	8	10	19.5	41	10
03047 00 01 X9 NB	10	12	19.5	42	10
03047 00 01 Y1 NB	12	14	19.5	42	10

### 3050

#### PORTAGOMMA FEMMINA

FEMALE HOSE ADAPTER  
 SCHLAUCHTÜLLE INNENGEW.  
 DOUILLE ANNELÉE FEMELLE  
 EPIGA HEMBRA  
 ESPIGÃO COM ROSCA FÊMEA

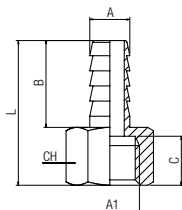

Code	A	A1	B	C	L	CH	Pack.
03050 00 01 BS NB	6	1/8	19.5	8.5	30	14	10
03050 00 01 BT NB	6	1/4	19.5	11	32.5	17	10
03050 00 01 BZ NB	7	1/8	19.5	8.5	30	14	10
03050 00 01 BX NB	7	1/4	19.5	11	32.5	17	10
03050 00 01 BJ NB	8	1/4	19.5	11	32.5	17	10
03050 00 01 CB NB	9	1/4	19.5	11	32.5	17	10
03050 00 01 CC NB	9	3/8	19.5	11.5	33.5	20	10
03050 00 01 CF NB	10	1/4	19.5	11	32.5	17	10
03050 00 01 CG NB	10	3/8	19.5	11.5	33.5	20	10
03050 00 01 CL NB	12	3/8	19.5	11.5	33.5	20	10
03050 00 01 CM NB	12	1/2	19.5	14.5	37.5	24	10

### 3055

#### RACCORDO A L PORTAGOMMA MASCHIO

MALE HOSE ADAPTER ELBOW  
 WINKELSCHLAUCHTÜLLE AUSSENGEW.  
 DOUILLE ANNELÉE COUDÉE  
 EPIGA A L MACHO  
 ESPIGÃO EM "L" COM ROSCA MACHO

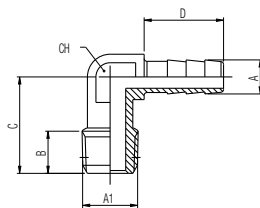

Code	A	A1	B	C	D	CH	Pack.
03055 00 01 BS NB	6	1/8	7.5	17	14	11	10
03055 00 01 BT NB	6	1/4	11	22	14	11	10
03055 00 01 BZ NB	7	1/8	7.5	17	14	11	10
03055 00 01 BX NB	7	1/4	11	22	14	11	10
03055 00 01 CB NB	9	1/4	11	22	14	11	10

### 3060

#### RACCORDO DI ATTRAVERSAMENTO

BULKHEAD CONNECTOR  
 SCHOTTVERSCHRAUBUNG  
 TRAVERSÉE DE CLOISON  
 RACOR PASATABIQUES  
 CONEXÃO PASSA-MURO

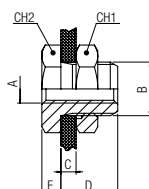

Code	A	B	C max	D	E	CH1	CH2	Pack.
03060 00 001	M5	M10x1	7	10.5	3.5	14	14	10
03060 00 002	1/8	M16x1.5	10	14	4	22	19	10
03060 00 003	1/4	M20x1.5	16	21	4	27	24	10
03060 00 004	3/8	M26x1.5	15	21	5	32	30	10
03060 00 005	1/2	M28x1.5	21	27	6	36	32	10
03060 00 011	3/4	M33x1.5	22.5	30.5	6	41	41	10

## 1704

### GHIERA

NUT  
MUTTER  
ECROU  
TUERCA PASATABIQUES  
PORCA

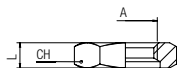

Code	A	L	CH	Pack.
01704 00 01 C8 NB	M10x1	4	14	50
01704 00 01 E3 NB	M16x1.5	5	22	50
01704 00 01 F2 NB	M20x1.5	6	27	50
01704 00 01 0V NB	M26x1.5	7	32	50
01704 00 01 H1 NB	M28x1.5	7	36	50
01704 00 01 22 NB	M33x1.5	8	41	50

## 4000

### RACCORDO A T FEMMINA

FEMALE TEE  
T-VERSCHRAUBUNG INNENGEW.  
TÉ ÉGAL FEMELLE  
RACOR A T HEMBRA  
CONEXÃO EM "T" COM ROSCA FÊMEA

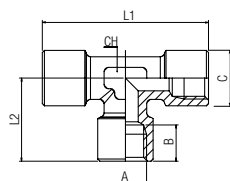

Code	A	B	L2	L1	C	CH	Pack.
04000 00 01 02 NB	1/8	8.5	19.5	39	13	12	10
04000 00 01 03 NB	1/4	11	24.5	49	16.5	13	10
04000 00 01 04 NB	3/8	12	27	54	20.5	16	10
04000 00 01 05 NB	1/2	15	32	64	25.5	20	10
04000 00 01 07 NT	3/4	16.5	36.5	73	32.5	27	10
04000 00 01 09 NT	1"	19	45	90	39.5	30	5

## 4010

### RACCORDO A T MASCHIO

MALE TEE  
T-VERSCHRAUBUNG AUSSENGEW.  
TÉ ÉGAL MÂLE  
RACOR A T MACHO  
CONEXÃO EM "T" COM ROSCA MACHO

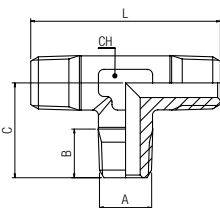

Code	A	B	C	L	CH	Pack.
04010 00 01 02 NB	1/8	8	17.5	35	12	10
04010 00 01 03 NB	1/4	11	23	46	13	10
04010 00 01 04 NB	3/8	11.5	25.5	51.5	16	10
04010 00 01 05 NB	1/2	14	29.5	59	20	10
04010 00 01 07 NT	3/4	14.5	32	64	27	10
04010 00 01 09 NT	1"	16.8	39	78	30	5

## 4020

### RACCORDO A T FEMMINA CENTRALE

CENTRE LEG FEMALE TEE  
T-VERSCHRAUBUNG INNENGEW. MITTIG  
TÉ ÉGAL MÂLE, CENTRE FEMELLE  
RACOR A T HEMBRA CENTRAL  
CONEXÃO EM "T" COM ROSCA FÊMEA CENTRAL

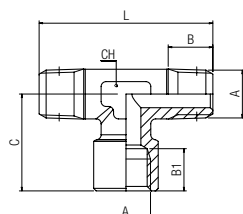

Code	A	B	B1	C	L	CH	Pack.
04020 00 01 02 NB	1/8	8	8.5	19.5	35	12	10
04020 00 01 03 NB	1/4	11	11	24.5	46	13	10
04020 00 01 04 NB	3/8	11.5	12	27	51	16	10
04020 00 01 05 NB	1/2	14	15	32	59	20	10
04020 00 01 07 NT	3/4	14.5	16.5	36.5	64	27	10
04020 00 01 09 NT	1"	16.8	19	45	78	30	5



### 4030

**RACCORDO A T FEMMINA LATERALE**

OFF SET FEMALE TEE  
 T-VERSCHRAUBUNG INNENGEW. SEITLICH  
 TÉ ÉGAL MÂLE, EN BOUT FEMELLE  
 RACOR A T HEMBRA LATERAL  
 CONEXÃO EM "T" COM ROSCA FÊMEA LATERAL

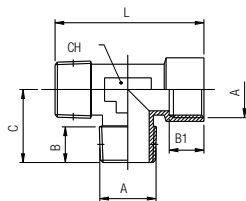

Code	A	B	B1	C	L	CH	Pack.
04030 00 01 02 NB	1/8	8	8.5	17.5	37	12	10
04030 00 01 03 NB	1/4	11	11	23	47.5	13	10
04030 00 01 04 NB	3/8	11.5	12	25.5	52.5	16	10
04030 00 01 05 NB	1/2	14	15	29.5	61.5	20	10
04030 00 01 07 NT	3/4	14.5	16.5	32	68.5	27	10
04030 00 01 09 NT	1"	16.8	19	39	84	30	5

### 4040

**RACCORDO A T MASCHIO CENTRALE**

CENTRE LEG MALE TEE  
 T-VERSCHRAUBUNG AUSSENGEW. MITTIG  
 TÉ ÉGAL FEMELLE, CENTRE MÂLE  
 RACOR A T MACHO CENTRAL  
 CONEXÃO EM "T" COM ROSCA MACHO CENTRAL

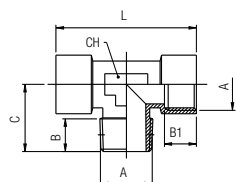

Code	A	B	B1	C	L	CH	Pack.
04040 00 01 B5 NB	M5	4	5.5	11	22	9	10
04040 00 01 02 NB	1/8	8	8.5	17.5	39	12	10
04040 00 01 03 NB	1/4	11	11	23	49	13	10
04040 00 01 04 NB	3/8	11.5	12	25.5	54	16	10
04040 00 01 05 NB	1/2	14	15	29.5	64	20	10
04040 00 01 07 NT	3/4	14.5	16.5	32	73	27	10
04040 00 01 09 NT	1"	16.8	19	39	90	30	5

### 4050

**RACCORDO A T MASCHIO LATERALE**

OFF SET MALE TEE  
 T-VERSCHRAUBUNG AUSSENGEW. SEITLICH  
 TÉ ÉGAL FEMELLE, EN BOUT MÂLE  
 RACOR A T MACHO LATERAL  
 CONEXÃO EM "T" COM ROSCA MACHO LATERAL

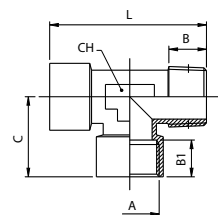

Code	A	B	B1	C	L	CH	Pack.
04050 00 01 B5 NB	M5	4	5.5	11	22	9	10
04050 00 01 02 NB	1/8	8	8.5	19.5	37	12	10
04050 00 01 03 NB	1/4	11	11	24.5	47.5	13	10
04050 00 01 04 NB	3/8	11.5	12	27	52.5	16	10
04050 00 01 05 NB	1/2	14	15	32	61.5	20	10
04050 00 01 07 NT	3/4	14.5	16.5	36.5	68.5	27	10
04050 00 01 09 NT	1"	16.8	19	45	84	30	5

### 5000

**RACCORDO A L MASCHIO**

MALE ELBOW  
 WINKELVERSCHRAUBUNG AUSSENGEW.  
 EQUERRE MÂLE  
 RACOR A L MACHO  
 CONEXÃO EM "L" COM ROSCA MACHO

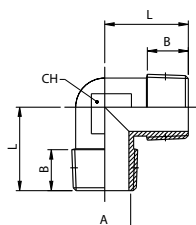

Code	A	B	L	CH	Pack.
05000 00 01 B5 NB	M5	4	11.9	9	10
05000 00 01 02 NB	1/8	7.5	18	11	10
05000 00 01 03 NB	1/4	11	24	13	10
05000 00 01 04 NB	3/8	12	27	17	10
05000 00 01 05 NB	1/2	14	29.5	20	10
05000 00 01 07 NT	3/4	14.5	32	27	10
05000 00 01 09 NT	1"	16.8	39	30	5

## 5010

### RACCORDO A L FEMMINA

FEMALE ELBOW  
WINKELVERSCHRAUBUNG INNENGEW.  
EQUERRE FEMELLE  
RACOR A L HEMBRA  
CONEXÃO EM "L" COM ROSCA FÊMEA

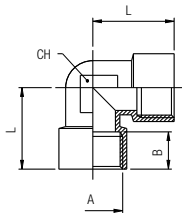

Code	A	B	L	CH	Pack.
05010 00 01 B5 NB	M5	5.5	11	9	10
05010 00 01 02 NB	1/8	8.5	21	11	10
05010 00 01 03 NB	1/4	11	25.5	13	10
05010 00 01 04 NB	3/8	11.5	28	17	10
05010 00 01 05 NB	1/2	15	32	20	10
05010 00 01 07 NT	3/4	16.5	36.5	27	10
05010 00 01 09 NT	1"	19	45	30	5

## 5020

### RACCORDO A L MASCHIO-FEMMINA

MALE-FEMALE ELBOW  
WINKELVERSCHRAUBUNG AUSSEN-/INNENGEW.  
EQUERRE MÂLE-FEMELLE  
RACOR A L MACHO - HEMBRA  
CONEXÃO EM "L" MACHO-FÊMEA

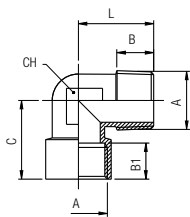

Code	A	B	B1	C	L	CH	Pack.
05020 00 01 B5 NB	M5	4	5.5	11.5	11.5	9	10
05020 00 01 02 NB	1/8	7.5	8.5	21	18	11	10
05020 00 01 03 NB	1/4	11	11	25.5	24	13	10
05020 00 01 04 NB	3/8	11.5	12	28	27	17	10
05020 00 01 05 NB	1/2	14	15	32	29.5	20	10
05020 00 01 07 NT	3/4	14.5	16.5	36.5	32	27	10
05020 00 01 09 NT	1"	16	19	45	39	30	5

## 5050

### RACCORDO A STAFFA 90° FEMMINA

FEMALE BRACKET FITTING 90°  
WANDBEFESTIGUNG 90° INNENGEW.  
APPLIQUE MURALE  
RACOR A L FIJACIÓN 90° CON SOPORTE  
CONEXÃO EM "L" COM ROSCA FÊMEA E SUPORTE DE FIXAÇÃO

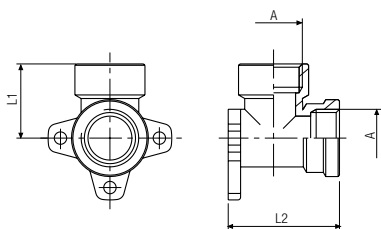

Code	A	L1	L2	Pack.
05050 00 01 05 NB	1/2	27	40.5	10

## 6000

### RACCORDO A Y 90° MASCHIO CENTRALE

CENTRAL MALE Y 90°  
Y-Verschraubung 90° AUSSEN-/INNENGEW.  
Y EGAL À 90° MALE AU CENTRE  
RACOR A Y 90° MACHO CENTRAL  
CONEXÕES EM "Y" 90° ROSCA MACHO CENTRAL

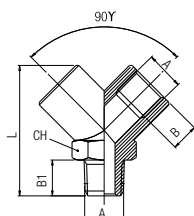

Code	A	B	B1	L	CH	Pack.
06000 00 01 02 NB	1/8	8.5	9	33	14	10
06000 00 01 03 NB	1/4	11	11	37	17	10
06000 00 01 04 NB	3/8	11.5	12.5	46	22	10
06000 00 01 05 NB	1/2	14	16.5	58	26	10

## 6010

### RACCORDO A Y 90° FEMMINA

FEMALE Y 90°

Y-VERSCHRAUBUNG 90° INNENGEW.

Y ÉGAL FEMELLE

RACOR A Y 90° HEMBRA

CONEXÃO EM "Y" COM ROSCA FÊMEA

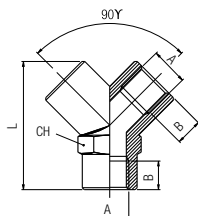

Code	A	B	L	CH	Pack.
06010 00 01 02 NB	1/8	8.5	33	14	10
06010 00 01 03 NB	1/4	11	37	17	10
06010 00 01 04 NB	3/8	11.5	46	22	10
06010 00 01 05 NB	1/2	14	58	26	10

## 6020

### RACCORDO A CROCE FEMMINA

FEMALE EQUAL CROSS

KREUZVERSCHRAUBUNG INNENGEW.

CROIX ÉGALE FEMELLE

RACOR A CRUZ HEMBRA

CONEXÃO CRUZETA COM ROSCA FÊMEA

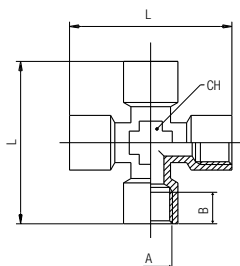

Code	A	B	L	CH	Pack.
06020 00 01 02 NB	1/8	8.5	39	11	10
06020 00 01 03 NB	1/4	11	50	13	10
06020 00 01 04 NB	3/8	12	56	17	10
06020 00 01 05 NB	1/2	15	64	20	10

## 6025

### RACCORDO A CROCE MASCHIO-FEMMINA

MALE-FEMALE EQUAL CROSS

KREUZVERSCHRAUBUNG AUSSEN-/INNENGEW.

CROIX ÉGALE MÂLE/FEMELLE

RACOR A CRUZ MACHO-HEMBRA

CONEXÃO CRUZETA MACHO-FÊMEA

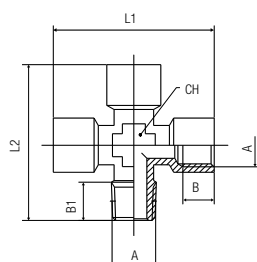

Code	A	B	B1	L1	L2	CH	Pack.
06025 00 01 02 NB	1/8	8.5	8	39	37	11	10
06025 00 01 03 NB	1/4	11	11	50	48.5	13	10
06025 00 01 04 NB	3/8	12	11.5	56	54	17	10
06025 00 01 05 NB	1/2	15	14	64	61	20	10

## 6030

### RACCORDO A CROCE MASCHIO

MALE EQUAL CROSS

KREUZVERSCHRAUBUNG AUSSENGEW.

CROIX ÉGALE MÂLE

RACOR A CRUZ MACHO

CONEXÃO CRUZETA COM ROSCA MACHO

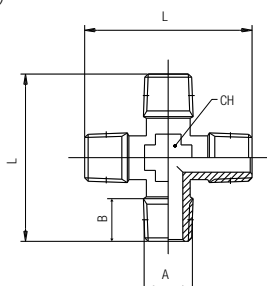

Code	A	B	L	CH	Pack.
06030 00 01 02 NB	1/8	8	35	11	10
06030 00 01 03 NB	1/4	11	47	13	10
06030 00 01 04 NB	3/8	11.5	52	17	10
06030 00 01 05 NB	1/2	14	58	20	10

## 6040

### RACCORDO A CROCE IN ALLUMINIO

ALUMINIUM TEE CROSS  
 KREUZVERTEILER AUS ALUMINIUM  
 CROIX DE DISTRIBUTION EN ALUMINIUM  
 RACOR A CRUZ EN ALUMINIO  
 CONEXÃO CRUZETA EM ALUMÍNIO

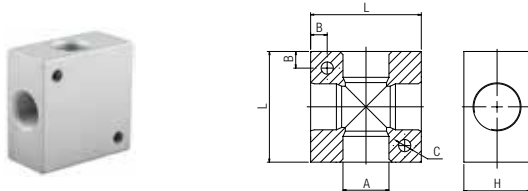

Code	A	L	H	B	C	Pack.
06040 00 11 02 AG	1/8	25	15	4.3	4.5	10
06040 00 11 03 AG	1/4	40	20	6.5	5.5	10
06040 00 11 04 AG	3/8	50	25	7.5	5.5	5
06040 00 11 05 AG	1/2	50	30	7.5	5.5	5

## 6047

### RIPARTITORE IN ALLUMINIO

ALUMINIUM DISTRIBUTION MANIFOLD  
 VERTEILERBLOCK AUS ALUMINIUM  
 NOURRICE DE DISTRIBUTION EN ALUMINIUM  
 REGLETA SIMPLE EN ALUMINIO  
 DISTRIBUIDOR EM ALUMÍNIO

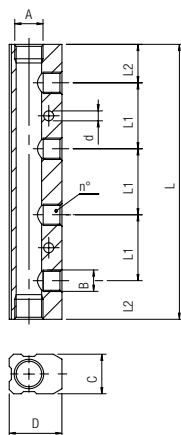

Code	A	B	N°	C	D	L1	L2	L	d	Pack.
06047 00 11 AJ AG	1/4	1/8	2	18	24	30	17.5	65	4.5	5
06047 00 11 AK AG	1/4	1/8	3	18	24	30	17.5	95	4.5	5
06047 00 11 AW AG	1/4	1/8	4	18	24	30	17.5	125	4.5	5
06047 00 11 BA AG	1/4	1/8	5	18	24	30	17.5	155	4.5	5
06047 00 11 BB AG	1/4	1/8	6	18	24	30	17.5	185	4.5	5
06047 00 11 BC AG	3/8	1/4	2	22	30	36	20	76	5.5	5
06047 00 11 BD AG	3/8	1/4	3	22	30	36	20	112	5.5	5
06047 00 11 BE AG	3/8	1/4	4	22	30	36	20	148	5.5	5
06047 00 11 BF AG	3/8	1/4	5	22	30	36	20	184	5.5	5
06047 00 11 BG AG	3/8	1/4	6	22	30	36	20	220	5.5	5
06047 00 11 ES AG	1/2	3/8	2	26	35	40	25	90	5.5	5
06047 00 11 ET AG	1/2	3/8	3	26	35	40	25	130	5.5	5
06047 00 11 EU AG	1/2	3/8	4	26	35	40	25	170	5.5	5
06047 00 11 EV AG	1/2	3/8	5	26	35	40	25	210	5.5	5
06047 00 11 EZ AG	1/2	3/8	6	26	35	40	25	250	5.5	5

## 6048

### RIPARTITORE DOPPIO IN ALLUMINIO

ALUMINIUM DOUBLE DISTRIBUTION MANIFOLD  
 DOPPELTER VERTEILERBLOCK AUS ALUMINIUM  
 NOURRICE DE DISTRIBUTION DOUBLE EN ALUMINIUM  
 REGLETA DOBLE EN ALUMINIO  
 DISTRIBUIDOR DUPLO EM ALUMÍNIO

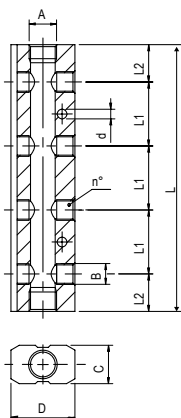

Code	A	B	N°	C	D	L1	L2	L	d	Pack.
06048 00 11 AJ AG	1/4	1/8	2	18	30	30	17.5	65	4.5	5
06048 00 11 AK AG	1/4	1/8	3	18	30	30	17.5	95	4.5	5
06048 00 11 AW AG	1/4	1/8	4	18	30	30	17.5	125	4.5	5
06048 00 11 BA AG	1/4	1/8	5	18	30	30	17.5	155	4.5	5
06048 00 11 BB AG	1/4	1/8	6	18	30	30	17.5	185	4.5	5
06048 00 11 BC AG	3/8	1/4	2	22	38	36	20	76	5.5	5
06048 00 11 BD AG	3/8	1/4	3	22	38	36	20	112	5.5	5
06048 00 11 BE AG	3/8	1/4	4	22	38	36	20	148	5.5	5
06048 00 11 BF AG	3/8	1/4	5	22	38	36	20	184	5.5	5
06048 00 11 BG AG	3/8	1/4	6	22	38	36	20	220	5.5	5
06048 00 11 ES AG	1/2	3/8	2	26	44	40	25	90	5.5	5
06048 00 11 ET AG	1/2	3/8	3	26	44	40	25	130	5.5	5
06048 00 11 EU AG	1/2	3/8	4	26	44	40	25	170	5.5	5
06048 00 11 EV AG	1/2	3/8	5	26	44	40	25	210	5.5	5
06048 00 11 EZ AG	1/2	3/8	6	26	44	40	25	250	5.5	5

## 6070

### RACCORDO A L MASCHIO-FEMMINA

MALE-FEMALE ELBOW FITTING  
 WINKELVERSCHRAUBUNG AUSSEN-/INNENGEW.  
 RACCORD EQUERRE MÂLE/FEMELLE  
 RACOR A L MACHO HEMBRA  
 CONEXÃO EM "L" MACHO-FÊMEA

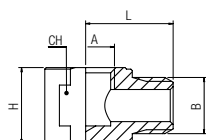

Code	A	B	H	L	CH	Pack.
06070 00 01 2W NB	1/8	1/8	13	15	13	10
06070 00 01 6W NB	1/4	1/4	18	19	18	10

## 6080

### RACCORDO A T MASCHIO-FEMMINA-FEMMINA

MALE-FEMALE-FEMALE TEE FITTING  
 T-VERSCHRAUBUNG AUSSEN-/INNEN-/INNENGEW.  
 RACCORD TÉ MÂLE / FEMELLE  
 RACOR A T MACHO-HEMBRA-HEMBRA  
 CONEXÃO EM "T" MACHO-FÊMEA

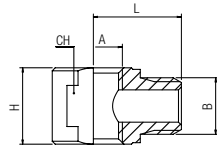

Code	A	B	H	L	CH	Pack.
06080 00 01 2W NT	1/8	1/8	13	15	13	10
06080 00 01 6W NT	1/4	1/4	18	18.5	18	10

## 6090

### ANELLO ORIENTABILE A L FEMMINA

FEMALE SINGLE BANJO BODY  
 RINGANSCHLUSS INNENGEW.  
 CORPS BANJO FEMELLE  
 ANILLO ORIENTABLE HEMBRA  
 ANEL ORIENTÁVEL EM "L" COM ROSCA FÊMEA

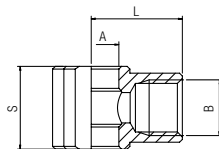

Code	B	A	L	S	Pack.
06090 00 01 02 NB	1/8	10	16.5	15	10
06090 00 01 03 NB	1/4	13	22	17	10
06090 00 01 04 NB	3/8	16.7	26	20	10

## 82205

**New**

### NIPPLA MASCHIO CONICO - NPTF

NIPPLE TAPER - NPTF  
 DOPPELNIPPEL KONISCH - NPTF  
 MAMELON DOUBLE CONIQUE - NPTF  
 MACHÓN CÓNICO - NPTF  
 NIPLE CÔNICA - NPTF

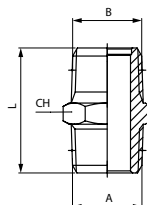

Code	A BSPT	B NPTF	L	CH	Pack.
82205 00 01 2W NB	1/8	1/8	20.5	12	10
82205 00 01 6W NB	1/4	1/4	29	14	10
82205 00 01 AB NB	3/8	3/8	29.5	18	10
82205 00 01 AG NB	1/2	1/2	36.5	22	10
82205 00 01 AN NB	3/4	3/4	40.5	27	10

## 82241

New

### ADATTATORE FEMMINA CILINDRICO - MASCHIO NPTF

ADAPTER FEMALE BSP - MALE NPTF

GEWINDESTUTZEN IG BSP - AG NPTF

ADAPTATEUR FEMELLE BSP - MÂLE NPTF

ADAPTADOR HEMBRA CILÍNDRICO BSP - MACHO NPTF

ADAPTADOR FÊMEA COM ROSCA PARALELA BSP - MACHO NPTF

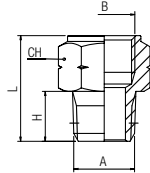

Code	A NPTF	B G	H	L	CH	Pack.
82241 00 01 8K NB	10/32 UNF	M5	14.5	12	8	10
82241 00 01 2W NB	1/8	1/8	8.5	19.5	14	10
82241 00 01 6W NB	1/4	1/4	13	27	17	10
82241 00 01 AB NB	3/8	3/8	13	28	22	10

## 82242

### ADATTATORE FEMMINA NPTF - MASCHIO CILINDRICO

ADAPTER FEMALE NPTF - MALE G THREAD

GEWINDESTUTZEN IG NPTF - AG BSP

ADAPTATEUR FEMELLE NPTF - MÂLE BSP

ADAPTADOR HEMBRA NPTF - MACHO BSP

ADAPTADOR FÊMEA NPTF - MACHO BSP

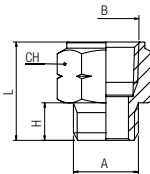

Code	A G	B NPTF	H	L	CH	Pack.
82242 00 01 2W NB	1/8	1/8	6	17	14	10
82242 00 01 6W NB	1/4	1/4	8	23	17	10
82242 00 01 AB NB	3/8	3/8	9	24	22	10
82242 00 01 AG NB	1/2	1/2	12	31.5	27	10

**New**

**RACCORDI FILETTATI - CW 510L**

CW 510L - NICKEL-PLATED BRASS ADAPTORS  
 GEWINDEVERSCHRAUBUNGEN - CW 510L  
 ACCESSOIRES DE RACCORDEMENT- ADAPTATEURS LAITON - CW 510L  
 RACORDAJE ROSCADO - CW 510L  
 ACESSÓRIOS ROSCADOS EM LATÃO NIQUELADO - CW510L



**CARATTERISTICHE TECNICHE**

TECHNICAL CHARACTERISTICS  
 TECHNISCHE ANGABEN  
 CARACTÉRISTIQUES TECHNIQUES  
 CARACTERÍSTICAS TÉCNICAS  
 CARACTERÍSTICAS TÉCNICAS



**Norma di Riferimento**

- Reference standard
- Entspricht der Norm
- Norme de référence
- Normativa de referencia
- Norma de referència

1907/2006 <b>REACH</b> ✓	2011/65/CE <b>RoHS</b> ✓	M.O.C.A. 1935/2004 CE
PED 2014/68/UE	SILICON FREE	



**Materiali e Componenti** **IT**  
 La maggior parte degli articoli di questa serie è composta da un unico particolare in CW 510L

**Component Parts and Materials** **GB**  
 The main part of these fittings is made in CW 510L

**Komponenten und Materialien** **DE**  
 Die meisten Artikel in dieser Serie werden aus CW 510L

**Matériaux et Composants** **FR**  
 La majeure partie des raccords de ce chapitre est fabriquée en laiton CW 510L

**Materiales y Componentes** **ES**  
 La mayor parte de los artículos de esta serie está compuesta de un solo material latón CW 510L

**Materials e Componentes** **PT**  
 A maior parte dos itens desta série é fabricada em CW 510L



Misura Size Grösse Dimensions Medida Tamanho	Pressione consigliata Pressure advised Empfohlener druck Pression conseillée Presión recomendada Pressão aconselhada
1/8	-0.99 bar ~ 150 bar
1/4	-0.99 bar ~ 100 bar



**Temperature massima**

Maximum temperature
Maximum temperatur
Température maximale
Temperatura máxima
Temperatura máxima

**+ 300 °C**



**Fluidi compatibili**

Aria compressa / Vuoto / Acqua / Vapore / Alimenti

**Fluids**

Compressed air / Vacuum / Water / Steam / Food

**Geeignete Medien**

Druckluft / Vakuum / Wasser / Dampf / Lebensmittel

**Fluides compatibles**

Air comprimé / Vide / Eau / Vapeur / Boissons

**Fluidos compatibles**

Aire comprimido / Vacío / Agua / Vapor / Alimentos

**Fluidos compatíveis**

Ar comprimido / Vácuo / Água / Vapor / Alimentos



**Tubi di Collegamento**

Tubi e raccordi in genere.

IT

**Connection Tubes**

Tubes and fittings in general.

GB

**Geeignete Rohre**

Rohre und Verschraubungen im Allgemeinen.

DE

**Tubes Conseillés**

Raccords et tubes compatibles.

FR

**Tubos de Conexión**

Tubo y racordaje en general.

ES

**Tubos de Conexão**

Tubos e conexões em geral.

PT



**Filettatura**

Gas conica conforme ISO 7.1, BS 21, DIN 2999.  
Gas cilindrica conforme ISO 228 Classe A.

IT

**Threads**

Tapered gas in conformity with ISO 7.1, BS 21, DIN 2999.  
Parallel gas in conformity with ISO 228 Class A.

GB

**Gewindearten**

Konisches Gewinde nach Norm ISO 7.1, BS 21, DIN 2999.  
Zylindrisches Gewinde nach Norm ISO 228 Classe A.

DE

**Filetages**

Filetage conique conforme: ISO 7.1, BS 21, DIN 2999.  
Filetage cylindrique conforme: ISO 228 Classe A.

FR

**Roscas**

Gas cónica conforme ISO 7.1, BS 21, DIN 2999.  
Gas cilíndrica conforme ISO 228 Clase A.

ES

**Roscas**

Gas cônica conforme ISO 7.1, BS 21, DIN 2999.  
Gas paralela conforme ISO 228 Classe A.

PT

**2000**

**NIPPLO CONICO**

NIPPLE (TAPER)

DOPPELNIPPEL KONISCH

MAMELON DOUBLE CONIQUE

MACHÓN CÓNICO

NIPLE COM ROSCA CÔNICA



Code	A	B	L	CH	Pack.
02000 00 89 02 00	1/8	7.5	19.5	12	50
02000 00 89 03 00	1/4	11	27	14	50

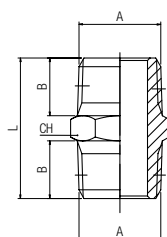



**2020**

**NIPLO DI RIDUZIONE CONICO**

REDUCING NIPPLE (TAPER)  
 DOPPELNIPPEL REDUZIERT KONISCH  
 MAMELON DOUBLE INÉGAL, CONIQUE  
 MACHÓN CÓNICO DE REDUCCIÓN  
 NIPLE DE REDUÇÃO COM ROSCA CÔNICA

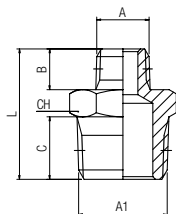

Code	A	A1	B	C	L	CH	Pack.
02020 00 89 AT 00	1/8	1/4	7.5	11	23.5	14	50

**3000**

**MANICOTTO**

SLEEVE  
 MUFFE  
 MANCHON  
 MANGUITO  
 LUVA

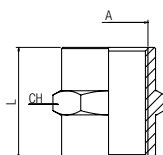

Code	A	L	CH	Pack.
03000 00 89 02 00	1/8	15	14	50
03000 00 89 03 00	1/4	22	17	50

**4000**

**RACCORDO A T FEMMINA**

FEMALE TEE  
 T-VERSCHRAUBUNG INNENGEW.  
 TÉ ÉGAL FEMELLE  
 RACOR A T HEMBRA  
 CONEXÃO EM "T" COM ROSCA FÊMEA

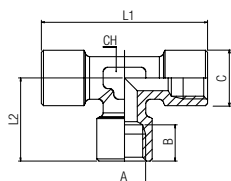

Code	A	B	L2	L1	C	CH	Pack.
04000 00 89 02 00	1/8	8.5	19.5	39	13	12	50
04000 00 89 03 00	1/4	11	24.5	49	16.5	13	25

**4040**

**RACCORDO A T MASCHIO CENTRALE**

CENTRE LEG MALE TEE  
 T-VERSCHRAUBUNG AUSSENGEW. MITTIG  
 TÉ ÉGAL FEMELLE, CENTRE MÂLE  
 RACOR A T MACHO CENTRAL  
 CONEXÃO EM "T" COM ROSCA MACHO CENTRAL

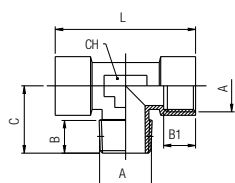

Code	A	B	B1	C	L	CH	Pack.
04040 00 89 02 00	1/8	8	8.5	17.5	39	12	50
04040 00 89 03 00	1/4	11	11	23	49	13	25

## 4050

### RACCORDO A T MASCHIO LATERALE

OFF SET MALE TEE

T-VERSCHRAUBUNG AUSSENGEW. SEITLICH

TÉ ÉGAL FEMELLE, EN BOUT MÂLE

RACOR A T MACHO LATERAL

CONEXÃO EM "T" COM ROSCA MACHO LATERAL

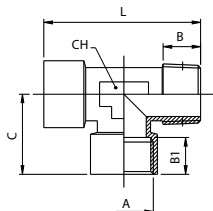

Code	A	B	B1	C	L	CH	Pack.
04050 00 89 02 00	1/8	8	8.5	19.5	37	12	50
04050 00 89 03 00	1/4	11	11	24.5	47.5	13	25

## 5000

### RACCORDO A L MASCHIO

MALE ELBOW

WINKELVERSCHRAUBUNG AUSSENGEW.

EQUERRE MÂLE

RACOR A L MACHO

CONEXÃO EM "L" COM ROSCA MACHO

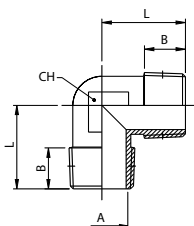

Code	A	B	L	CH	Pack.
05000 00 89 02 00	1/8	7.5	18	11	50
05000 00 89 03 00	1/4	11	24	13	25

## 5010

### RACCORDO A L FEMMINA

FEMALE ELBOW

WINKELVERSCHRAUBUNG INNENGEW.

EQUERRE FEMELLE

RACOR A L HEMBRA

CONEXÃO EM "L" COM ROSCA FÊMEA

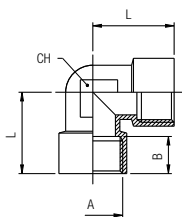

Code	A	B	L	CH	Pack.
05010 00 89 02 00	1/8	8.5	21	11	50
05010 00 89 03 00	1/4	11	25.5	13	25

## 5020

### RACCORDO A L MASCHIO-FEMMINA

MALE-FEMALE ELBOW

WINKELVERSCHRAUBUNG AUSSEN-/INNENGEW.

EQUERRE MÂLE-FEMELLE

RACOR A L MACHO - HEMBRA

CONEXÃO EM "L" MACHO-FÊMEA

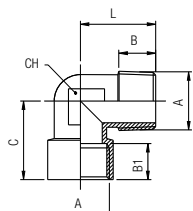

Code	A	B	B1	C	L	CH	Pack.
05020 00 89 02 00	1/8	7.5	8.5	21	18	11	50
05020 00 89 03 00	1/4	11	11	25.5	24	13	25

**dB\***

Livello di rumore in (dB) a 6 bar - Noise level in (dB) at 6 bar - Geräuschpegel (dB) bei 6 bar  
Niveau sonore (dB) à 6 bar - Nivel de ruido en (dB) a 6 bar - Nivel de ruído em (dB) a 6 bar

## 7000

### SILENZIATORE

SILENCER  
SCHALLDÄMPFER  
SILENCIEUX D'ÉCHAPPEMENT  
SILENCIADOR  
SILENCIADOR

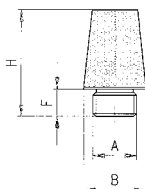

Code	A	F	B	H	dB*	Pack.
07000 00 001	1/8	4.5	12.5	21	81	10
07000 00 002	1/4	6	15	25	83	10
07000 00 003	3/8	8.5	19	34.5	87	10
07000 00 004	1/2	8	23	43	90	10
07000 00 005	3/4	9	30	50	92 a 4 Bar	10
07000 00 006	1"	11	37	60.5	92 a 4 Bar	10

	min	max
Temperature	- 10 °C	+ 80 °C
Pressure		10 bar
Soglia di filtrazione - Filtration threshold - Filterfeinheit Capacité de filtration - Grado de filtración - Limite de filtragem		50 µm

## 7005

### SILENZIATORE REGOLABILE

SILENCER ADJUSTABLE  
SCHALLDÄMPFER REGULIERBAR  
SILENCIEUX D'ÉCHAPPEMENT RÉGLABLE  
SILENCIADOR REGULABLE  
SILENCIADOR AJUSTÁVEL

**New**

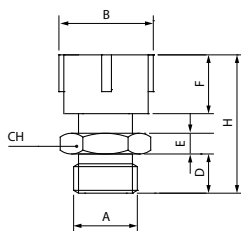

Code	A	F	B	H <sub>min</sub>	H <sub>max</sub>	D	E	CH	Pack
07005 00 001	1/8	12	15	25	27	8	4	14	10
07005 00 002	1/4	14	18.5	28	30	8	4	17	10
07005 00 003	3/8	16	23.5	33	38	10	5	22	10
07005 00 004	1/2	18	28	39	46	12	7	27	10

	min	max
Temperature	- 20 °C	+ 150 °C
Pressure		10 bar
Soglia di filtrazione - Filtration threshold - Filterfeinheit Capacité de filtration - Grado de filtración - Limite de filtragem		50 µm

## 7010

### SILENZIATORE

SILENCER  
SCHALLDÄMPFER  
SILENCIEUX D'ÉCHAPPEMENT  
SILENCIADOR  
SILENCIADOR

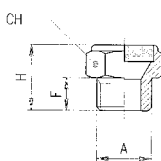

Code	A	F	H	CH	dB*	Pack.
07010 00 001	1/8	6	14	13	73	10
07010 00 002	1/4	7	17	16	74	10
07010 00 003	3/8	8	18	19	85	10
07010 00 004	1/2	10	20	24	89	10
07010 00 005	3/4	10	23	30	90	10

	min	max
Temperature	- 10 °C	+ 80 °C
Pressure		12 bar
Soglia di filtrazione - Filtration threshold - Filterfeinheit Capacité de filtration - Grado de filtración - Limite de filtragem		100 µm

## 7020

### SILENZIATORE CON RETE IN FILO DI ACCIAIO INOX 304

SILENCER WITH WIRE MESH STAINLESS STEEL 304  
SCHALLDÄMPFER MIT EDELSTAHLDRAHT 304  
SILENCIEUX D'ÉCHAPPEMENT AVEC FILS EN ACIERS INOXYDABLES 304  
SILENCIADOR CON ALAMBRE DE ACERO INOXIDABLE 304  
SILENCIADOR FIO DE ACO INOXIDAVEL 304

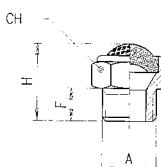

Code	A	F	H	CH	dB*	Pack.
07020 00 001	M5	4	9	8	-	10
07020 00 002	1/8	6	15	13	74	10
07020 00 003	1/4	7	18	16	72	10
07020 00 004	3/8	8	20	19	88	10
07020 00 005	1/2	10	22	24	90	10
07020 00 006	3/4	10	26	30	90	10
07020 00 007	1"	12	28	36	92	10

	min	max
Temperature	- 10 °C	+ 80 °C
Pressure		12 bar
Soglia di filtrazione - Filtration threshold - Filterfeinheit Capacité de filtration - Grado de filtración - Limite de filtragem		100 µm

## 7030

### SILENZIATORE

SILENCER  
SCHALLDÄMPFER  
SILENCIEUX D'ÉCHAPPEMENT  
SILENCIADOR  
SILENCIADOR

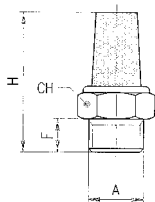

Code	A	F	H	CH	dB*	Pack.
07030 00 001	M5	4	17	8	-	10
07030 00 008	M7x1	5	23	10	75	10
07030 00 002	1/8	6	29	13	81	10
07030 00 003	1/4	7	32	16	82	10
07030 00 004	3/8	8	40	19	85	10
07030 00 005	1/2	9	45	24	-	10
07030 00 006	3/4	10	56	30	-	10
07030 00 007	1"	12	66	36	-	10

	min	max
<b>Temperature</b>	- 10 °C	+ 80 °C
<b>Pressure</b>		10 bar
<b>Soglia di filtrazione - Filtration threshold - Filterfeinheit</b> <i>Capacité de filtration - Grado de filtración - Limite de filtragem</i>		50 µm

## 7040

### SILENZIATORE

SILENCER  
SCHALLDÄMPFER  
SILENCIEUX D'ÉCHAPPEMENT  
SILENCIADOR  
SILENCIADOR

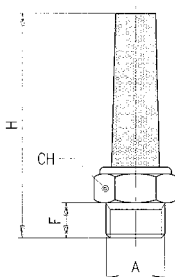

Code	A	F	H	CH	dB*	Pack.
07040 00 001	1/8	6	44	13	76	10
07040 00 002	1/4	7	50	16	75	10
07040 00 003	3/8	8	54	19	88	10
07040 00 004	1/2	9	67	24	89	10
07040 00 005	3/4	9	65	30	-	10

	min	max
<b>Temperature</b>	- 10 °C	+ 80 °C
<b>Pressure</b>		12 bar
<b>Soglia di filtrazione - Filtration threshold - Filterfeinheit</b> <i>Capacité de filtration - Grado de filtración - Limite de filtragem</i>		36 µm

## 7050

### SILENZIATORE

SILENCER  
SCHALLDÄMPFER  
SILENCIEUX D'ÉCHAPPEMENT  
SILENCIADOR  
SILENCIADOR

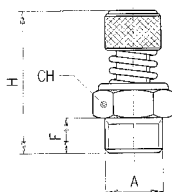

Code	A	F	H min	H max	CH	dB*	Pack.
07050 00 001	1/8	6	26	28	13	72	10
07050 00 002	1/4	8	30	32	15	73	10
07050 00 003	3/8	10	35	38	22	84	10
07050 00 004	1/2	11	37	40	22	88	10

	min	max
<b>Temperature</b>	- 10 °C	+ 80 °C
<b>Pressure</b>		12 bar
<b>Soglia di filtrazione - Filtration threshold - Filterfeinheit</b> <i>Capacité de filtration - Grado de filtración - Limite de filtragem</i>		100 µm

## 7060

### SILENZIATORE A CALZAMENTO PER TUBI

PUSH-ON SILENCER  
ÜBERWURFSCHALLDÄMPFER  
SILENCIEUX D'ÉCHAPPEMENT À CANULE  
SILENCIADOR RÁPIDO  
SILENCIADOR PUSH-ON

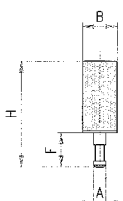

Code	Tube	A	F	B	H	dB*	Pack.
07060 00 002	5/3	3.5	8	8	25.5	-	10
07060 00 003	6/4	5	10	8	26	-	10

	min	max
<b>Temperature</b>	- 10 °C	+ 80 °C
<b>Pressure</b>		10 bar
<b>Soglia di filtrazione - Filtration threshold - Filterfeinheit</b> <i>Capacité de filtration - Grado de filtración - Limite de filtragem</i>		50 µm

**7070**

**SILENZIATORE IN RESINA (POM) CON MATERIALE PP FONOASSORBENTE**  
 SILENCER MADE IN RESIN (POM) WITH PP SOUNDPROOFING MATERIAL  
 SCHALLDÄMPFER AUS ACETAL MIT KUNSTSTOFFWOLLE  
 SILENCIEUX EN ACETAL AVEC RÉSINE  
 SILENCIADOR DE RESINA (POM) CON MATERIAL PP FONOABSORBENTE  
 SILENCIADOR EM RESINA (POM) COM MATERIAL PP A PROVA DE SOM

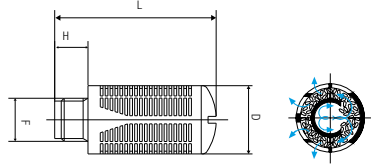

Code	F	H	D	L	dB*	Pack.
07070 00 001	1/8	6	15	32.5	87	10
07070 00 002	1/4	8	19.5	43	84	10
07070 00 003	3/8	11	24.5	58	90	10
07070 00 004	1/2	11	24.5	58	90	10
07070 00 005	3/4	18	48	115	91	5
07070 00 006	1"	18	48	115	90	5

	min	max
<b>Temperature</b>	- 10 °C	+ 50 °C
<b>Pressure</b>	6 bar	

**7080**

**SILENZIATORE IN PA66 E FELTRO**  
 SILENCER MADE IN PA66 WITH FELT  
 SCHALLDÄMPFER PA66 MIT FILZ  
 SILENCIEUX EN PA66 AVEC DU FEUTRE  
 SILENCIADOR EN PA66 Y FILTRO  
 SILENCIADOR EM PA66 E FELTRO

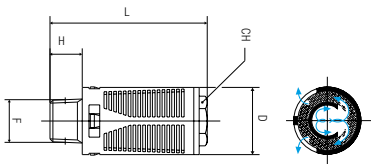

Code	F	H	D	L	CH	dB*	Pack.
07080 00 001	1/8	6	16	34	2	87	10
07080 00 002	1/4	8	19	44	12	90	10
07080 00 003	3/8	10	24	56	17	92	10
07080 00 004	1/2	10	24	56	17	92	10
07080 00 005	3/4	18	48	115	-	-	5
07080 00 006	1"	18	48	115	-	-	5

	min	max
<b>Temperature</b>	- 10 °C	+ 70 °C
<b>Pressure</b>	6 bar	

**Attenuazione del suono**

IT

Il diagramma mostra la distribuzione della frequenza dell'energia del suono da un getto d'aria ad una pressione di circa 6 bar da un tipico scarico di uscita di una valvola pneumatica da 1/2".

La zona critica fra 1 e 4 KHz, è la zona dove l'udito umano è più sensibile e dove gli effetti psicologici agli alti livelli di rumore sono più dannosi.

Come si nota dal diagramma l'attenuazione del suono è di circa 20-25 dB ad una pressione di 6 bar.

**Sound Attenuation**

GB

In the diagram is shown the frequency distribution of the sound energy in an 6 bar air jet from a typical 1/2" control valve exhaust port.

The critical region is that between 1 and 4 KHz, the range where psychological effects at high noise levels are most damaging.

Sound reduction for this silencer is approx mately 20-25 dB at 6 bar working pressure.

**Längsschalldämmung**

DE

Dieses Diagramm zeigt die Frequenzverteilung der Schallenergie, bei einem Luftstrahl von 6 bar Druck, aus einem typischen, pneumatischen Ablassventil mit 1/2".

Der kritische Bereich ist jener zwischen 1 und 4 kHz, der Bereich, bei dem die psychologischen Auswirkungen durch hohen Lärmpegel am schädlichsten sind.

Die Schalldämmung durch diesen Schalldämpfer beträgt rund 20-25 dB bei 6 bar Betriebsdruck.

**Réduction sonore**

FR

Le schéma suivant représente le niveau sonore d'un jet d'air à 6 bar dans un échappement de 1/2".

La zone critique aux bruits où les effets psychologiques sont nocifs se situe dans une plage de 1 à 4 kHz.

Ce silencieux diminue le bruit d'environ 20-25 dB à une pression de travail de 6 bar.

**Atenuación del sonido**

ES

El diagrama muestra la distribución de la frecuencia del sonido de una muestra de aire a una presión de 6 bar de un típico escape de una válvula neumática de 1/2".

La zona crítica entre 1 y 4 KHz, es la donde el oído humano es más sensible y donde los efectos psicológicos a los altos niveles de sonido son más dañinos.

Como se observa en el diagrama la atenuación del sonido es de cerca de 20-25 dB a una presión de 6 bar.

**Atenuação acústica**

PT

O diagrama mostra a distribuição da frequência da energia do som de um jato de ar a uma pressão pneumática de cerca de 6 bar de um típico escape de saída de uma válvula pneumática de 1/2".

A zona crítica entre 1 e 4 KHz, é a zona onde a audição humana é mais sensível e onde os efeitos psicológicos dos ruído podem causar maiores danos.

Como se pode notar no diagrama, a atenuação do som é de cerca de 20-25 dB a uma pressão de trabalho de 6 bar.

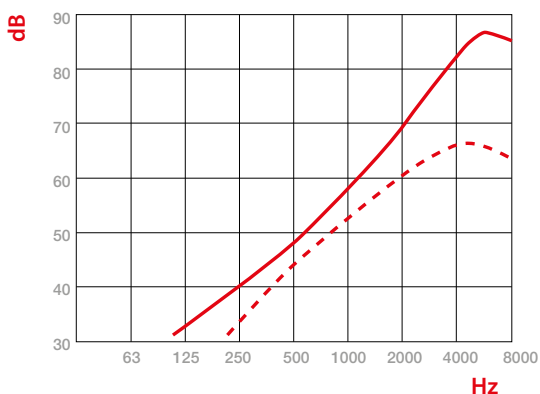

**dB re 2x10<sup>-5</sup> N/m<sup>2</sup>**

Livello di pressione acustica  
 Octave band sound pressure levels  
 Schalldruck Pegel  
 Niveau de pression acoustique  
 Nivel de presión acústica  
 Nivel de pressão sonora

**Hz**

Frequenza acustica  
 Octave band centre frequencies  
 Akustische Frequenz  
 Fréquence acoustique  
 Frecuencia acústica  
 Frequência acústica

**—**

Scarico libero  
 Exhaust to atmosphere  
 Kostenlose Auspuff  
 Échappement Libre  
 Escape libre  
 Descarga livre

**- - - -**

Scarico silenziato  
 Silenced exhaust  
 Schalldämpfer  
 Silencieux d'échappement  
 Escape silenciado  
 Silenciador de escape

## AS7100

### SILENZIATORE IN POLIETILENE PER RACCORDI AUTOMATICI

POROUS POLYETHYLENE SILENCER FOR PUSH-IN  
 STECK-SCHALLDÄMPFER POLYETHYLEN  
 SILENCIEUX ENCLIQUETABLE EN POLYÉTHYLÈNE  
 SILENCIADOR EN POLIETILENO PARA RACORDAJE AUTOMÁTICO  
 SILENCIADOR EM POLIETILENO PARA CONEXÃO PUSH-IN

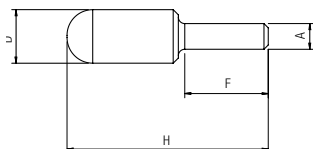

Code	A	F	H±3	D	Pack.
AS710 00 001	4	14	32	7,5	10
AS710 00 002	6	17	45	13	10
AS710 00 003	8	18	43,5	14	10
AS710 00 004	10	22,7	57,5	16	10
AS710 00 005	12	24,5	82	19	10

	min	max
<b>Temperature</b>	- 15 °C	+ 100 °C
<b>Pressure</b>		10 bar
<b>Soglia di filtrazione - Filtration threshold - Filterfeinheit</b> Capacité de filtration - Grado de filtración - Limite de filtragem		75 µm

## 7100

### SILENZIATORE IN POLIETILENE

POROUS POLYETHYLENE SILENCER  
 SCHALLDÄMPFER POLYETHYLEN  
 SILENCIEUX EN POLYÉTHYLÈNE  
 SILENCIADOR EN POLIETILENO  
 SILENCIADOR EM POLIETILENO

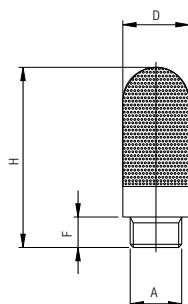

Code	A	F	H	D	Pack.
07100 00 001	M5	4	23	6,5	10
07100 00 002	1/8	6	34	12,5	10
07100 00 003	1/4	7	42,5	15,5	10
07100 00 004	3/8	11,5	67,5	18,5	10
07100 00 005	1/2	11	78	23,5	10
07100 00 006	3/4	15,5	130	38,5	5
07100 00 007	1"	19,5	160	49	5

	min	max
<b>Temperature</b>	- 15 °C	+ 100 °C
<b>Pressure</b>		10 bar
<b>Soglia di filtrazione - Filtration threshold - Filterfeinheit</b> Capacité de filtration - Grado de filtración - Limite de filtragem		75 µm

### GRAFICO SILENZIATORE 7110 1/4 - PRESSIONE A 6 BAR

TEST GRAPH 7110 1/4" - 6 BAR PRESSURE  
 GRAFIK FÜR 7110 1/4 - 6 BAR DRUCK  
 GRAPHIQUE POUR 7110 1/4 - 6 BAR PRESSION  
 GRÁFICA PARA 7110 1/4 - 6 BAR DE PRESIÓN  
 GRÁFICO PARA 7110 1/4 - 6 BAR DE PRESSÃO

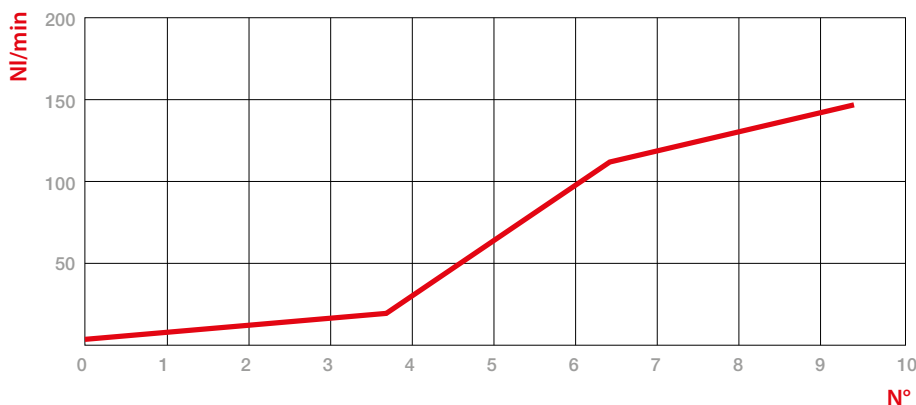

#### NI/min

Portata  
 Flow  
 Durchfluss  
 Débit  
 Caudal  
 Vazão

#### N°

Giri vite di regolazione  
 Adjustment screw turns  
 Umdrehungen an der einstellnadel  
 Nombre de tours de réglage  
 Giros de tornillo regulador  
 Numero de voltas agulha ajuste

IT

L'unione di un'accurata e facile regolazione con gli elementi dei silenziatori porosi in polietilene aumenta quelle che sono le prestazioni di questo articolo, le cui caratteristiche sono riportate nel grafico.

GB

The combination of accurate and easy adjustment with the porous polyethylene silencing increase the performance of this article, which characteristics are shown in the diagram.

DE

Die Kombination von präziser und einfacher Regulierung, mit einem Schalldämpfer aus porösem Polyethylen, erhöhen die Leistungsfähigkeit dieses Artikels, dessen Merkmale im folgenden Diagramm dargestellt werden:

FR

Le réglage précis et facile du silencieux en polyéthylène permet d'augmenter les performances de cet article. Ces performances sont indiquées dans le diagramme.

ES

La unión de una curada y fácil regulación con los elementos del silenciador poroso en polietileno aumentan las prestaciones de este artículo, las características del cual son representadas en el gráfico adjunto.

PT

A união de uma precisa e fácil regulagem aos elementos silenciadores porosos em polietileno aumenta significativamente a performance do silenciador, cujas características podem ser verificadas no gráfico ao lado.

## 7110

### SILENZIATORE IN POLIETILENE CON REGOLAZIONE DI SCARICO

POROUS POLYETHYLENE RESTRICTOR SILENCER

SCHALLDÄMPFER POLYETHYLEN MIT EINSTELLBARER ABLUFT

SILENCIEUX RÉGLEUR DE DÉBIT

SILENCIADOR EN POLIETILENO CON REGULACIÓN DE ESCAPE

SILENCIADOR EM POLIETILENO COM REGULAGEM DE ESCAPE

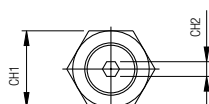
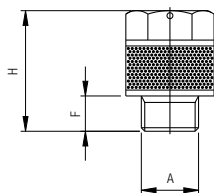

Code	A	F	H	CH1	CH2	Pack.
07110 00 001	M5	5	16	8	1.5	10
07110 00 002	1/8	6	20.5	13	2.5	10
07110 00 003	1/4	7	29	15	4	10
07110 00 004	3/8	8	38	20	6	10
07110 00 005	1/2	10	50	25	8	10

	min	max
<b>Temperature</b>	- 15 °C	+ 100 °C
<b>Pressure</b>		10 bar
<b>Soglia di filtrazione - Filtration threshold - Filterfeinheit</b> Capacité de filtration - Grado de filtración - Limite de filtragem		75 µm

## 7120

### SILENZIATORE A PASTIGLIA CON TAGLIO CACCIAVITE

PAD SILENCER WITH SLOT FOR SCREWDRIVER

MINI-SCHALLDÄMPFER

SILENCIEUX COMPACT

SILENCIADOR DE PASTILLA CON CORTE PARA DESTORNILLADOR

SILENCIADOR TIPO PASTILHA COM FENDA PARA CHAVE

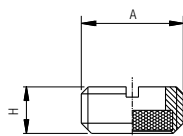

Code	A	H	Pack.
07120 00 001	1/8	4	10
07120 00 002	1/4	6	10
07120 00 003	3/8	6	10
07120 00 004	1/2	9	10
07120 00 005	3/4	10	10
07120 00 006	1"	10	10

	min	max
<b>Temperature</b>	- 10 °C	+ 80 °C
<b>Pressure</b>		10 bar
<b>Soglia di filtrazione - Filtration threshold - Filterfeinheit</b> Capacité de filtration - Grado de filtración - Limite de filtragem		120 µm

## 7130

### SILENZIATORE A PASTIGLIA FILTRANTE CONICO TAGLIO CACCIAVITE

SILENCER WITH FILTERING PAD - (TAPER) WITH SLOT FOR SCREWDRIVER

MINI-SCHALLDÄMPFER MIT KONUSFILTER

SILENCIEUX COMPACT AVEC CÔNE INTÉRIEUR

SILENCIADOR DE PASTILLA FILTRANTE CÓNICO CON CORTE PARA DESTORNILLADOR

SILENCIADOR TIPO PASTILHA FILTRANTE CÓNICO C/ FENDA PARA CHAVE

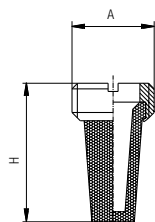

Code	A	H	Pack.
07130 00 001	1/8	15	10
07130 00 002	1/4	18	10
07130 00 003	3/8	21	10
07130 00 004	1/2	27	10
07130 00 005	3/4	36	10
07130 00 006	1"	46	10

	min	max
<b>Temperature</b>	- 10 °C	+ 80 °C
<b>Pressure</b>		10 bar
<b>Soglia di filtrazione - Filtration threshold - Filterfeinheit</b> Capacité de filtration - Grado de filtración - Limite de filtragem		50 µm

## 7140

### SILENZIATORE INTEGRALE CON TAGLIO CACCIAVITE

INTEGRAL SILENCER WITH SLOT FOR SCREWDRIVER

SCHALLDÄMPFER VOLLGESINTERT

SILENCIEUX EN BRONZE FRITTÉ AVEC FENTE DE SERRAGE

SILENCIADOR INTEGRAL CON CORTE PARA DESTORNILLADOR

SILENCIADOR INTEGRAL COM FENDA PARA CHAVE

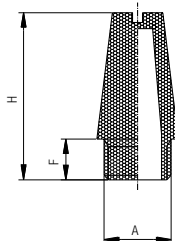

Code	A	H	F	Pack.
07140 00 001	1/8	21	5.5	10
07140 00 002	1/4	27	8.5	10
07140 00 003	3/8	36	11	10
07140 00 004	1/2	44	11	10
07140 00 005	3/4	63	13	10
07140 00 006	1"	75	15	10

	min	max
<b>Temperature</b>	- 20 °C	+ 150 °C
<b>Pressure</b>		10 bar
<b>Soglia di filtrazione - Filtration threshold - Filterfeinheit</b> <i>Capacité de filtration - Grado de filtración - Limite de filtragem</i>		50 µm

## 7150

### SILENZIATORE INTEGRALE CON CHIAVE ESAGONALE

INTEGRAL SILENCER WITH HEXAGONAL WRENCH

SCHALLDÄMPFER VOLLGESINTERT

SILENCIEUX EN BRONZE FRITTÉ AVEC 6 PANS DE SERRAGE MÂLE

SILENCIADOR INTEGRAL CON LLAVE HEXAGONAL

SILENCIADOR INTEGRAL COM ENCAIXE PARA CHAVE DE BOCA

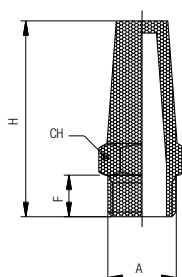

Code	A	CH	H	F	Pack.
07150 00 001	1/8	28	6	13	10
07150 00 002	1/4	31.4	8	17	10
07150 00 003	3/8	36	10	22	10
07150 00 004	1/2	44	12	27	10
07150 00 005	3/4	54	14	32	10
07150 00 006	1"	66	16	41	10

	min	max
<b>Temperature</b>	- 20 °C	+ 150 °C
<b>Pressure</b>		10 bar
<b>Soglia di filtrazione - Filtration threshold - Filterfeinheit</b> <i>Capacité de filtration - Grado de filtración - Limite de filtragem</i>		50 µm



**RACCORDI CON ATTACCO A BAIONETTA**

FITTINGS WITH BAYONET CONNECTION  
 VERSCHRAUBUNGEN MIT BAJONETT-VERSCHLUSS  
 RACCORDS À FERMETURE À BAIONNETTE  
 RACORDAJE CON CONEXIÓN A BAYONETA  
 CONEXÕES COM ENCAIXE TIPO BAIONETTA



**CARATTERISTICHE TECNICHE**

TECHNICAL CHARACTERISTICS  
 TECHNISCHE ANGABEN  
 CARACTÉRISTIQUES TECHNIQUES  
 CARACTERÍSTICAS TÉCNICAS  
 CARACTERÍSTICAS TÉCNICAS



**Norma di Riferimento**

- Reference standard
- Entspricht der Norm
- Norme de référence
- Normativa de referencia
- Norma de referência

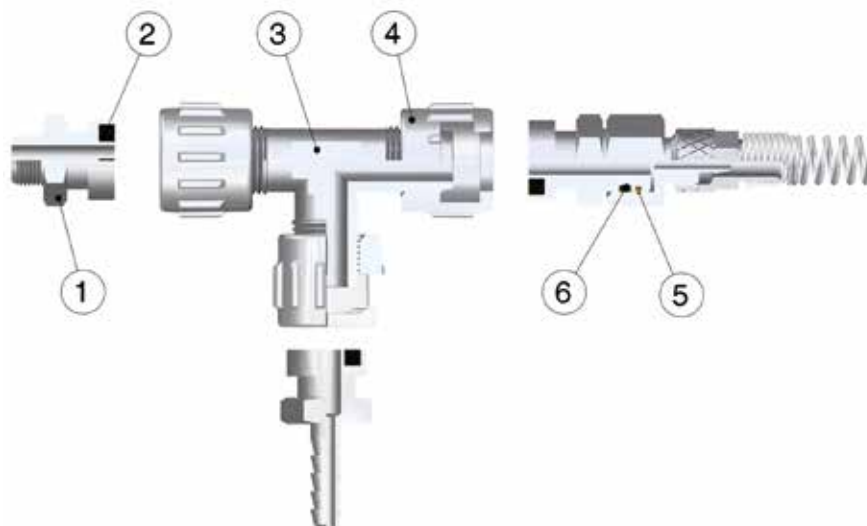
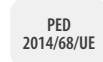

Materiali e Componenti	IT	Component Parts and Materials	GB	Komponenten und Materialien	DE
1 Baionetta in Ottone Nichelato 2 Guarnizione in NBR 90 3 Corpo in ottone nichelato 4 Dado capettato in zama nichelato 5 Seeger in bronzo 6 Guarnizione o-ring in NBR 70		1 Nickel-plated brass Bayonet 2 NBR 90 Seals 3 Nickel-plated brass Body 4 Nickel-plated zamac Milled Nut 5 Bronze Seeger 6 NBR 70 o-ring seal		1 Bajonettanschluss Messing vernickelt 2 Dichtung NBR 90 3 Körper Messing vernickelt 4 Rändelmutter Zamak vernickelt 5 Seegerring Bronze 6 Dichtung O-Ring NBR 70	
Matériaux et Composants	FR	Materiales y Componentes	ES	Materiais e Componentes	PT
1 Raccord baïonnette: laiton nickelé 2 Joint: NBR 90 3 Corps: laiton nickelé 4 Ecrou moleté: Zamac nickelé 5 Circlips: bronze 6 Joint torique: NBR 70		1 Bayoneta en latón niquelado 2 Junta en NBR 90 3 Cuerpo en latón niquelado 4 Tuerca en níquel plateado zamac 5 Seeger en bronce 6 Junta o-ring en NBR 70		1 Baioneta em Latão Niquelado 2 Vedação em NBR 90 3 Corpo em Latão Niquelado 4 Porca recartilhada em zamac Niquelado 5 Anel de retenção tipo Seeger em bronze 6 Vedação o-ring em NBR 70	



**Pressioni**

- Pressures
- Druckbereich
- Pressions
- Presiones
- Pressões
- 0.99 bar** (-0.099 MPa)
- 15 bar** (1.5 MPa)



**Temperature**

- Temperatures
- Temperatur
- Températures
- Temperaturas
- Temperaturas
- 20 °C**
- + 70 °C**



**Fluidi compatibili**

Aria compressa, fluidi e liquidi a bassa pressione compatibili con il tipo di accoppiamento.

**Fluids**

Compressed air, fluids and liquids at low pressure compatible with the connection.

**Geeignete Medien**

Druckluft, Medien und Flüssigkeiten bei niedrigem Druck die kompatibel mit den Anschlüssen sind.

**Fluides compatibles**

Air comprimé et fluides compatibles avec les matériaux des composants.

**Fluidos compatibles**

Aire comprimido, fluidos o líquidos a baja presión compatibles con el tipo de conexión.

**Fluidos compatíveis**

Ar comprimido, fluidos e líquidos a baixa pressão compatíveis com o tipo de conexão.



<b>Filettatura</b> Gas cilindrica conforme ISO 228 Classe A. Metrica conforme ISO R/262.	<b>IT</b>	<b>Threads</b> Parallel gas in conformity with ISO 228 Class A. Metric in conformity with ISO R/262.	<b>GB</b>	<b>Gewindearten</b> Zylindrisches Gewinde nach Norm ISO 228 Classe A. Metrisches Gewinde nach Norm ISO R/262.	<b>DE</b>
--	-----------	--	-----------	---	-----------

<b>Filetages</b> Filetage cylindrique conforme: ISO 228 Classe A. Filetage métrique conforme: ISO R/262.	<b>FR</b>	<b>Roscas</b> Gas cilíndrica conforme ISO 228 Clase A. Métrica conforme ISO R/262.	<b>ES</b>	<b>Roscas</b> Gas paralela conforme ISO 228 Classe A. Métrica conforme ISO R/262.	<b>PT</b>
--	-----------	--	-----------	---	-----------

## 1810

**RACCORDI PER TUBI IN GOMMA**  
FITTING FOR RUBBER HOSE  
VERSCHRAUBUNG FÜR GUMMISCHLAUCH  
RACCORD POUR TUBE CAOUTCHOUC  
RACORDAJE PARA TUBERÍA EN GOMA  
CONEXÃO PARA TUBOS DE BORRACHA

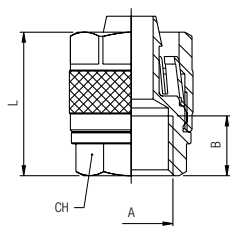

Code	Tube	A	B	L	CH	Pack.
01810 00 003	14/6	1/4	11	30	16	10
01810 00 005	17/8	1/4	11	31	16	10
01810 00 006	19/10	1/4	11	31	17	10
01810 00 007	23/13	1/2	17	36	24	10



**RACCORDI PER TUBI IN POLIURETANO INTRECCIATO**  
FITTINGS FOR BRAIDED POLYURETHANE HOSES  
VERSCHRAUBUNG FÜR POLYURETHANROHR MIT GEWEBE  
RACCORD POUR TUBE POLYURÉTHANE TRESSÉ  
RACORDAJE PARA TUBO EN POLIURETANO TRENZADO  
CONEXÕES PARA TUBOS EM POLIURETANO TRANÇADO



Code	Tube	A	B	L	CH	Pack.
01810 00 001	10/6	1/4	11	30	15	10
01810 00 002	12/8	1/4	11	31	16	10
01810 00 004	15/10	1/4	11	31	17	10



## 1830

**RACCORDO MASCHIO A BAIONETTA**  
MALE BAYONET  
BAJONETTANSCHLUSS AUSSENGEW.  
RACCORD DROIT MÂLE  
MACHO A BAYONETA  
CONEXÃO COM ROSCA MACHO E ENCAIXE TIPO BAIONETA

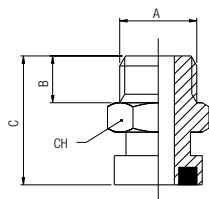

Code	A	B	C	CH	Pack.
01830 00 001	1/8	6	19.5	15	10
01830 00 002	1/4	8	22	15	10
01830 00 003	3/8	9	23	19	10

## 1831

**RACCORDO FEMMINA A BAIONETTA**  
FEMALE BAYONET  
BAJONETTANSCHLUSS INNENGEW.  
RACCORD DROIT FEMELLE  
HEMBRA A BAYONETA  
CONEXÃO COM ROSCA FÊMEA E ENCAIXE TIPO BAIONETA

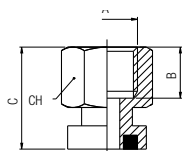

Code	A	B	C	CH	Pack.
01831 00 001	1/8	8.5	19.5	15	10
01831 00 002	1/4	11	22	17	10
01831 00 003	3/8	11	22	20	10

## 1832

### RACCORDO BAIONETTA A RESCA

BAYONET WITH REST  
 BAJONETTANSCHLUSS MIT SCHLAUCHTÜLLE  
 RACCORD DROIT À CANULE  
 ESPIGA A BAYONETA  
 CONEXÃO ESPIGÃO E ENCAIXE TIPO BAIONETA

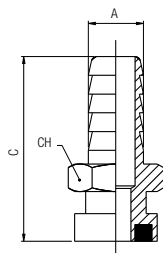

Code	A	C	CH	Pack.
01832 00 001	6	33.5	15	10
01832 00 002	7	33.5	15	10
01832 00 003	8	33.5	15	10
01832 00 004	9	33.5	15	10
01832 00 005	10	33.5	15	10
01832 00 006	12	33.5	15	10

## 1833

### RACCORDO BAIONETTA PORTAGOMMA

BAYONET FOR RUBBER HOSE  
 BAJONETTANSCHLUSS FÜR GUMMISCHLAUCH  
 RACCORD DROIT POUR TUBE CAOUTCHOUC  
 BAYONETA PORTAGOMA  
 CONEXÃO PARA MANGUEIRA DE BORRACHA E ENCAIXE TIPO BAIONETA

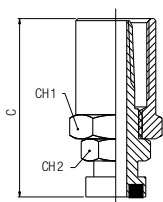

Code	Tube	CH1	CH2	C	Pack.
01833 00 001	14/6	17	15	44.5	10
01833 00 002	17/8	20	15	44.5	10
01833 00 003	19/10	22	15	44.5	10

## 1840

### RACCORDO MASCHIO PORTAGOMMA

MALE FOR RUBBER HOSE  
 VERSCHRAUBUNG FÜR GUMMISCHLAUCH AUSSENGEW.  
 RACCORD DROIT MÂLE POUR TUBE CAOUTCHOUC  
 MACHO PORTAGOMA  
 CONEXÃO COM ROSCA MACHO PARA MANGUEIRA DE BORRACHA

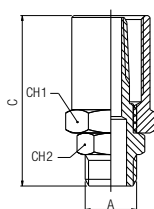

Code	Tube	A	CH1	CH2	C	Pack.
01840 00 008	10/6	1/4	15	17	43	10
01840 00 009	12/8	1/4	15	17	43	10
01840 00 001	14/6	1/4	17	17	43	10
01840 00 010	15/10	1/4	18	17	43	10
01840 00 002	17/8	1/4	20	17	43	10
01840 00 003	17/8	3/8	20	19	44	10
01840 00 006	17/10	1/4	20	17	43	10
01840 00 004	19/10	1/4	22	17	43	10
01840 00 005	19/10	3/8	22	19	44	10

## 1841

### RACCORDO FEMMINA PORTAGOMMA

FEMALE FOR RUBBER HOSE  
 VERSCHRAUBUNG FÜR GUMMISCHLAUCH INNENGEW.  
 RACCORD DROIT FEMELLE POUR TUBE CAOUTCHOUC  
 HEMBRA PORTAGOMA  
 CONEXÃO COM ROSCA FÊMEA PARA MANGUEIRA DE BORRACHA

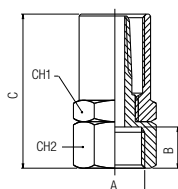

Code	Tube	A	B	C	CH1	CH2	Pack.
01841 00 006	10/6	1/4	11	43	15	17	10
01841 00 007	12/8	1/4	11	43	15	17	10
01841 00 001	14/6	1/4	11	43	17	17	10
01841 00 008	15/10	1/4	11	43	18	17	10
01841 00 002	17/8	1/4	11	43	20	17	10
01841 00 003	17/8	3/8	11.5	43.5	20	20	10
01841 00 004	19/10	1/4	11	43	22	17	10
01841 00 005	19/10	3/8	11.5	43.5	22	20	10

## 1850

### RACCORDO MASCHIO CON DADO CAPETTATO

MALE WITH MILLED NUT

VERSCHRAUBUNG MIT RÄNDELMUTTER AUSSENGEW.

RACCORD DROIT MÂLE AVEC ÉCROU MOLETÉ

MACHO CON TUERCA

CONEXÃO COM ROSCA MACHO E PORCA RECARILHADA

Code	A	B	CH	Pack.
01850 00 001	1/8	6	14	10
01850 00 002	1/4	8	15	10
01850 00 003	3/8	9	19	10

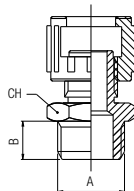

## 1851

### RACCORDO FEMMINA CON DADO CAPETTATO

FEMALE WITH MILLED NUT

VERSCHRAUBUNG MIT RÄNDELMUTTER INNENGEW.

RACCORD DROIT FEMELLE AVEC ÉCROU MOLETÉ

HEMBRA CON TUERCA

CONEXÃO COM ROSCA FÊMEA E PORCA RECARILHADA

Code	A	B	CH	Pack.
01851 00 001	1/4	11	17	10
01851 00 002	3/8	11	20	10

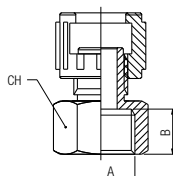

## 1852

### RACCORDO DOPPIO DADO CAPETTATO

DOUBLE MILLED NUT

VERBINDUNGSVERSCHRAUBUNG MIT RÄNDELMUTTERN

RACCORD UNION AVEC ÉCROUS MOLETÉS

UNIÓN CON TUERCA

CONEXÃO DE DUAS PORCAS RECARILHADAS

Code	A	CH	Pack.
01852 00 001	1/4	15	10

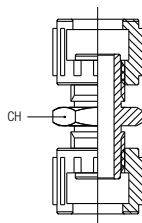

## 1853

### RACCORDO T CON DADI CAPETTATI

TEE WITH MILLED NUTS

T-VERSCHRAUBUNG MIT RÄNDELMUTTERN

RACCORD TÉ AVEC ÉCROUS MOLETÉS

T CON TUERCA

CONEXÃO EM "T" COM PORCAS RECARILHADAS

Code	A	CH	Pack.
01853 00 001	1/4	15	10

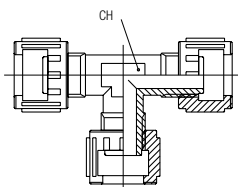

## 1855

### RACCORDO DIRITTO CON ATTACCO A BAIONETTA + DADO CON MOLLA

STRAIGHT FITTING WITH BAYONET CONNECTION + NUT AND SPRING  
 VERSCHRAUBUNG MIT BAJONETT-VERSCHLUSS + KNICKSCHUTZFEDER  
 RACCORD DROIT AVEC RESSORT DE PROTECTION  
 RACOR RECTO A BAYONETA + TUERCA CON MUELLE  
 CONEXÃO RETA COM ENCAIXE TIPO BAIONETA + PORCA COM MOLA

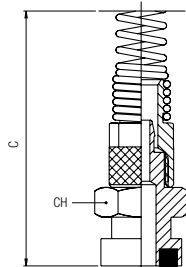

Code	Tube	C	CH	Pack.
01855 00 001	6/4	110	15	10
01855 00 002	8/6	115	15	10
01855 00 003	10/8	123	15	10
01855 00 004	12/10	130	16	10

## 1860

### RACCORDO DIRITTO ORIENTABILE CON ATTACCO A BAIONETTA + DADO CON MOLLA

ORIENTING STRAIGHT FITTING WITH BAYONET CONNECTION + NUT AND SPRING  
 VERSCHRAUBUNG DREHBAR MIT BAJONETT-VERSCHLUSS + KNICKSCHUTZFEDER  
 RACCORD DROIT ORIENTABLE AVEC RESSORT DE PROTECTION  
 RACOR RECTO GIRATORIO A BAYONETA + TUERCA CON MUELLE  
 CONEXÃO RETA ORIENTÁVEL COM ENCAIXE TIPO BAIONETA + PORCA COM MOLA

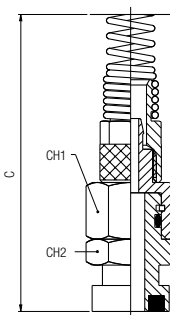

Code	Tube	C	CH1	CH2	Pack.
01860 00 001	6/4	120	15	15	10
01860 00 002	8/6	125	15	15	10
01860 00 003	10/8	134	15	15	10
01860 00 004	12/10	141	17	17	10

## 1808

### DADO CAPETTATO

MILLED NUT  
 RÄNDELMUTTER  
 ÉCROU MOLETÉ  
 TUERCA  
 PORCA RECARTILHADA

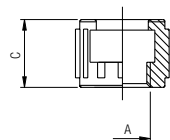

Code	A	C	Pack.
01808 00 80 03 NT	1/4	16	20

## 1864

### GUARNIZIONE DI TENUTA PER RACCORDI CON ATTACCO A BAIONETTA

TIGHTENING SEAL FOR FITTINGS WITH BAYONET CONNECTION  
 DICHTUNG FÜR BAJONETT-ANSCHLÜSSE  
 JOINT POUR RACCORD À BAIÛNNETTE  
 JUNTA PARA RACORES A BAYONETA  
 VEDAÇÃO PARA CONEXÕES COM ENCAIXE TIPO BAIONETA

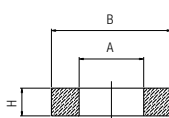

Code	A	B	H	Pack.
01864 00 24 Z7 00	7	13	3	50

**RACCORDI PORTAGOMMA PER TUBI IN MATERIALE PLASTICO**

HOSE ADAPTERS FOR PLASTIC TUBES  
 SCHLAUCHARMATUREN FÜR KUNSTSTOFFROHRE  
 RACCORDS À CANULE POUR TUBES PLASTIQUES  
 RACORDAJE PORTAGOMA PARA TUBO EN MATERIAL PLÁSTICO  
 CONEXÕES ESPIGÃO PARA TUBOS EM MATERIAL PLÁSTICO



**CARATTERISTICHE TECNICHE**

TECHNICAL CHARACTERISTICS  
 TECHNISCHE ANGABEN  
 CARACTÉRISTIQUES TECHNIQUES  
 CARACTERÍSTICAS TÉCNICAS  
 CARACTERÍSTICAS TÉCNICAS



1907/2006

REACH

2011/65/CE

RoHS

PED

2014/68/UE

SILICON

FREE

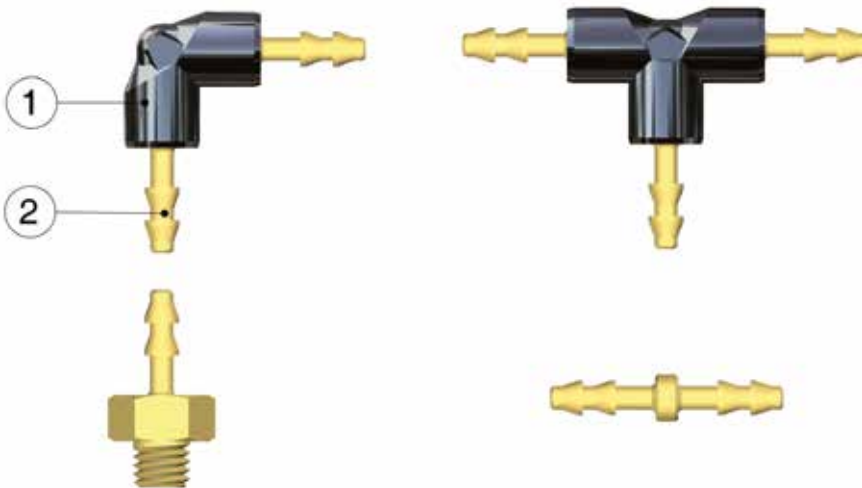

**Materiali e Componenti**

IT

- 1 Corpo in Tecnopolimero
- 2 Portagomma in ottone

**Component Parts and Materials**

GB

- 1 Tecnopolymer Body
- 2 Brass Hose Adapter

**Komponenten und Materialien**

DE

- 1 Körper Technopolymer
- 2 Schlauchtülle Messing

**Matériaux et Composants**

FR

- 1 Corps: technopolymère
- 2 Canule: laiton

**Materiales y Componentes**

ES

- 1 Cuerpo en tecnopolímero
- 2 Portagoma en latón

**Materiais e Componentes**

PT

- 1 Corpo em Tecnopolímero
- 2 Espigão em Latão



**Pressioni**

Pressures  
 Druckbereich  
 Pressions  
 Presiones  
 Pressões

**-0.99 bar** (-0.099 MPa)

**10 bar** (1 MPa)



**Temperature**

Temperatures  
 Temperatur  
 Températures  
 Temperaturas  
 Temperaturas

**- 10 °C**

**+ 80 °C**



**Fluidi compatibili**

Aria compressa

Fluids  
 Compressed air

Geeignete Medien  
 Druckluft

Fluides compatibles  
 Air comprimé

Fluidos compatibles  
 Aire comprimido

Fluidos compatíveis  
 Ar comprimido



**Tubi di Collegamento**

IT

Tubi in materiale plastico.

**Connection Tubes**

GB

Plastic tubes.

**Geeignete Rohre**

DE

Kunststoffrohre.

**Tubes Conseillés**

FR

Tubes plastiques.

**Tubos de Conexión**

ES

Tubos en material plástico.

**Tubos de Conexão**

PT

Tubos em material plástico.



**Filettatura**

IT

Metrica conforme ISO R/262.

**Threads**

GB

Metric in conformity with ISO R/262.

**Gewindearten**

DE

Metrisches Gewinde nach Norm ISO R/262.

**Filetages**

FR

Filetage métrique conforme: ISO R/262.

**Roscas**

ES

Métrica conforme ISO R/262.

**Roscas**

PT

Métrica conforme ISO R/262.

## 15000

### RACCORDO PORTAGOMMA DIRITTO MASCHIO

STRAIGHT HOSE MALE ADAPTOR  
 VERSCHRAUBUNG MIT SCHLAUCHTÜLLE AUSSENGEW.  
 RACCORD DROIT MÂLE À CANULE  
 RACOR PORTAGOMA RECTO MACHO  
 CONEXÃO ESPIGÃO RETA COM ROSCA MACHO

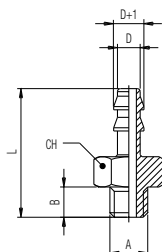

Code	D	A	B	L	CH	Pack.
15000 00 01 4V 00	2	M5	4	17	8	10
15000 00 01 6Q 00	3	M5	4	17	8	10
15000 00 01 0R 00	4	M5	4	18	8	10
15000 00 01 7S 00	6	M5	4	18	8	10

## 15040

### RACCORDO PORTAGOMMA DIRITTO INTERMEDIO

STRAIGHT HOSE ADAPTOR  
 VERBINDUNGSVERSCHRAUBUNG MIT SCHLAUCHTÜLLEN  
 RACCORD UNION À CANULES  
 RACOR PORTAGOMA RECTO INTERMEDIO  
 CONEXÃO ESPIGÃO RETA

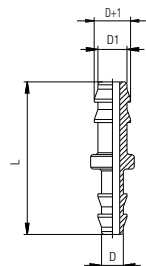

Code	D	D1	L	Pack.
15040 00 01 W9 00	2	2	20	10
15040 00 01 FG 00	3	2	20	10
15040 00 01 X0 00	3	3	20	10
15040 00 01 FH 00	4	3	21	10
15040 00 01 X1 00	4	4	22	10
15040 00 01 FM 00	6	4	22	10
15040 00 01 X4 00	6	6	22	10

## 15130

### RACCORDO PORTAGOMMA A L INTERMEDIO

ELBOW HOSE ADAPTOR  
 WINKELVERSCHRAUBUNG MIT SCHLAUCHTÜLLEN  
 RACCORD EQUERRE À CANULES  
 RACOR PORTAGOMA A L INTERMEDIO  
 CONEXÃO ESPIGÃO EM "L"

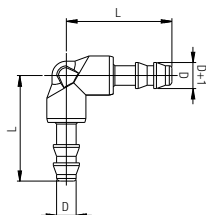

Code	D	L	Pack.
15130 00 001	2	17.5	10
15130 00 002	3	17.5	10
15130 00 003	4	22	10
15130 00 004	6	22	10

## 15230

### RACCORDO PORTAGOMMA A T INTERMEDIO

TEE HOSE ADAPTOR  
 T-VERSCHRAUBUNG MIT SCHLAUCHTÜLLEN  
 RACCORD TÉ À CANULES  
 RACOR PORTAGOMA A T INTERMEDIO  
 CONEXÃO ESPIGÃO EM "T"

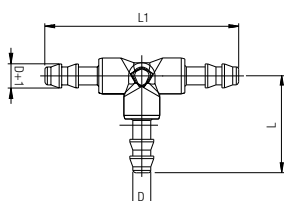

Code	D	L	L1	Pack.
15230 00 001	2	17.5	35	10
15230 00 002	3	17.5	35	10
15230 00 003	4	22	44	10
15230 00 004	6	22	44	10

